

# MIDLAND

CONCRETE



## FORMATS.FORMATI.FORMATOS



**60X120**  
59,55x119,3 cm - 23.45"x46.97"

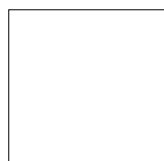

**60X60**  
59,55x59,55 cm - 23.45"x23.45"



**30X60**  
29,75x59,55 cm - 11.71"x23.45"

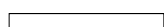

**7,5X60**  
7,3x59,55 cm - 2.87"x23.45"

## COLOURS COLORI COLORES



Ivory



Grey



Vison

## SPECIAL PIECES.PEZZI SPECIALI.PIEZAS ESPECIALES

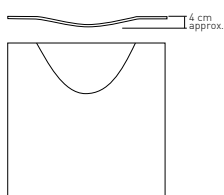

**60X120 Bag\***  
59,55x119,30 cm - 23.45"x46.96"  
**60X60 Bag\***  
59,55x59,55 cm - 23.45"x23.45"  
**30X60 Bag\***  
29,75x59,55 cm - 11.71"x23.45"

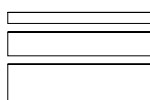

**15X60 - 10x60 - 5x60**  
multiformat natural\*  
14,75x59,55 cm - 5.87"x23.45"  
9,72x59,55 cm - 3.83"x23.45"  
4,84x59,55 cm - 1.90"x23.45"



**7,5X60**  
7,3x59,55 cm - 2.87"x23.45"



**30X30 mosaico 5x5**  
29,75x29,55 cm - 11.71"x11.71"



**30X30 mosaico 5x5 Multex**  
29,75x29,55 cm - 11.71"x11.71"



**30X30 mosaico 3D**  
28,5x28,5 cm - 11.22"x11.22"

## FINISHES FINITURI ACABADOS



Natural



Corrugato

## THICKNESS.SPESSORE.ESPESORES

± 0,74 cm / 0.29" approx.

## BASE TILES.BASE.BASES



**Midland ivory natural**  
119,30x59,55 cm - 46.96"x23.45"  
G-6372



**Midland ivory natural**  
59,55x59,55 cm - 23.45"x23.45"  
G-6224



**Midland ivory natural**  
29,75x59,55 cm - 11.71"x23.45"  
G-6194

## SPECIAL PIECES.PEZZI SPECIALI. PIEZAS ESPECIALES



**Midland ivory natural multiformato**  
4,84x59,55 cm - 1.90"x23.45"  
9,72x59,55 cm - 3.82"x23.45"  
14,75x59,55 cm - 5.80"x23.45"  
G-6346



**Midland ivory corrugato**  
29,75x59,55 cm - 11.71"x23.45"  
G-6234



**Midland ivory natural lista 60**  
7,3x59,55 cm - 2.87"x23.45"  
G-5087



**Midland ivory rodapié-60**  
7,3x59,55 cm - 2.87"x23.45"  
G-5091

\*\* For projects check technical information with our commercial network.  
\*\*Per i progetti ottenere informazioni tecniche attraverso la nostra rete commerciale.  
\*\* Para proyectos obtenga información técnica a través de nuestra red comercial.



MIDLAND

Midland ivory natural 59.55x119.30 cm

## BASE TILES.BASE.BASES



**Midland grey natural**  
119,30x59,55 cm - 46.96"x23.45"  
G-6372



**Midland grey natural**  
59,55x59,55 cm - 23.45"x23.45"  
G-6224



**Midland grey natural**  
29,75x59,55 cm - 11.71"x23.45"  
G-6194

## SPECIAL PIECES.PEZZI SPECIALI. PIEZAS ESPECIALES

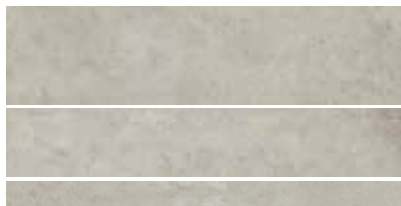

**Midland grey natural multiformato**  
4,84x59,55 cm - 1.90"x23.45"  
9,72x59,55 cm - 3.82"x23.45"  
14,75x59,55 cm - 5.80"x23.45"  
G-6346



**Midland grey corrugato**  
29,75x59,55 cm - 11.71"x23.45"  
G-6234



**Midland grey natural lista 60**  
7,3x59,55 cm - 2.87"x23.45"  
G-5087

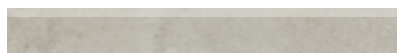

**Midland grey rodapié-60**  
7,3x59,55 cm - 2.87"x23.45"  
G-5091

\*\* For projects check technical information with our commercial network.  
\*\*Per i progetti ottenere informazioni tecniche attraverso la nostra rete commerciale.  
\*\* Para proyectos obtenga información técnica a través de nuestra red comercial.

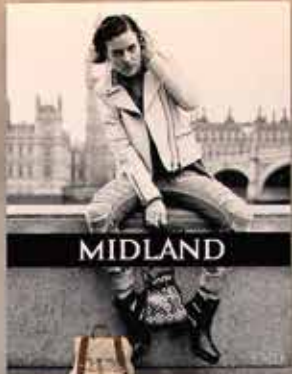
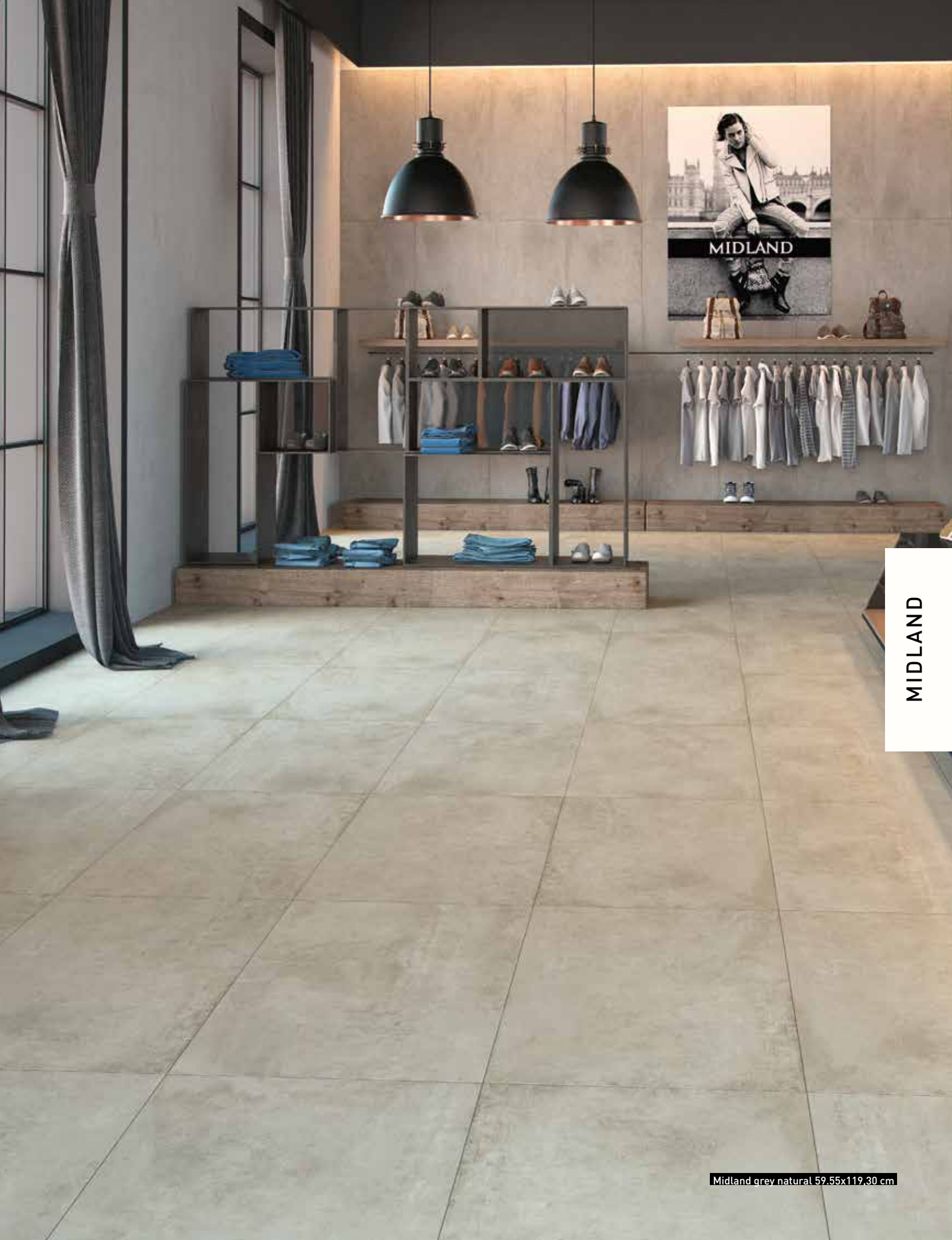

MIDLAND

Midland grey natural 59,55x119,30 cm

## BASE TILES.BASE.BASES



**Midland vison natural**  
119,30x59,55 cm - 46.96"x23.45"  
G-6372



**Midland vison natural**  
59,55x59,55 cm - 23.45"x23.45"  
G-6224



**Midland vison natural**  
29,75x59,55 cm - 11.71"x23.45"  
G-6194

## SPECIAL PIECES.PEZZI SPECIALI. PIEZAS ESPECIALES

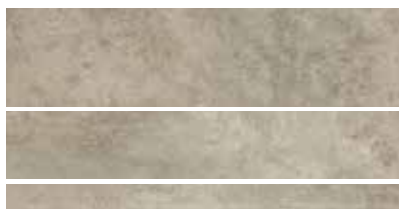

**Midland vison natural multiformato**  
4,84x59,55 cm - 1.90"x23.45"  
9,72x59,55 cm - 3.82"x23.45"  
14,75x59,55 cm - 5.80"x23.45"  
G-6346



**Midland vison corrugato**  
29,75x59,55 cm - 11.71"x23.45"  
G-6234



**Midland vison natural lista 60**  
7,3x59,55 cm - 2.87"x23.45"  
G-5087



**Midland vison rodapié-60**  
7,3x59,55 cm - 2.87"x23.45"  
G-5091

\*\* For projects check technical information with our commercial network.  
\*\*Per i progetti ottenere informazioni tecniche attraverso la nostra rete commerciale.  
\*\* Para proyectos obtenga información técnica a través de nuestra red comercial.



MIDLAND

Midland vison natural 59.55x59.55 cm



# MIDLAND

corrugato

CLASE 3  
UNE - ENV 12633

R11  
DIN 51130

DCOF>0.42  
ANSI A 137.1 - 2012

natural

CLASE 1  
UNE - ENV 12633

R9\*\*  
DIN 51130

DCOF>0.42  
ANSI A 137.1 - 2012

## SPECIAL PIECES. PEZZI SPECIALI. PIEZAS ESPECIALES



**Midland ivory mosaico 3D\***  
28,5x28,5 cm - 11.22"x11.22"  
G-5187



**Midland ivory-gold mos. 3D\***  
28,5x28,5 cm - 11.22"x11.22"  
G-5211



**Midland ivory-silver mos. 3D\***  
28,5x28,5 cm - 11.22"x11.22"  
G-5211

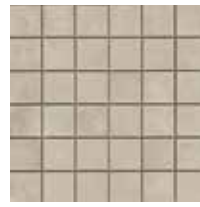

**Midland ivory mosaico 5x5**  
29,75x29,75 cm - 11.71"x11.71"  
G-6644



**Midland ivory mos. multitec 5x5**  
29,75x29,75 cm - 11.71"x11.71"  
G-6666



**Midland grey mosaico 3D\***  
28,5x28,5 cm - 11.22"x11.22"  
G-5187



**Midland grey-gold mos 3D\***  
28,5x28,5 cm - 11.22"x11.22"  
G-5211



**Midland grey-silver mos 3D\***  
28,5x28,5 cm - 11.22"x11.22"  
G-5211



**Midland grey mosaico 5x5**  
29,75x29,75 cm - 11.71"x11.71"  
G-6644



**Midland grey mos. multitec 5x5**  
29,75x29,75 cm - 11.71"x11.71"  
G-6666



**Midland vison mosaico 3D\***  
28,5x28,5 cm - 11.22"x11.22"  
G-5187



**Midland vison-gold mos 3D\***  
28,5x28,5 cm - 11.22"x11.22"  
G-5211



**Midland vison-silver mos 3D\***  
28,5x28,5 cm - 11.22"x11.22"  
G-5211



**Midland vison mosaico 5x5**  
29,75x29,75 cm - 11.71"x11.71"  
G-6644



**Midland vison mos. multitec 5x5**  
29,75x29,75 cm - 11.71"x11.71"  
G-6666

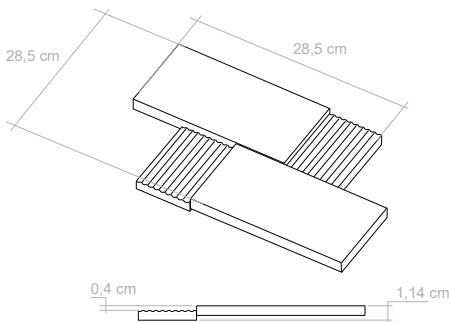

Physical Vapor Deposition (PVD)

Pvd is a field in the application of nanotechnology. The process consists of depositing layers of atoms, inside a vacuum chamber, to a solid surface. The layering is produced by the condensation of a vaporized metal (such as gold, titanium, platinum etc.) over the selected surface. Advantages: High resistance to abrasion and scratches; much higher than metals applied by firing. As a general rule, any non-aggressive, pH neutral product have to be used. Do not mix pieces from different lots. El PVD es uno de los campos de aplicación de la nanotecnología. El proceso consiste en depositar capas de átomos, en una cámara de alto vacío, sobre una superficie sólida. El recubrimiento se produce por la condensación de un metal vaporizado, oro, titanio, platino, ect, sobre el material a recubrir. Ventajas: Mayor resistencia al rayado y a la abrasión que los metales aplicados por cocción. Para la limpieza de estos materiales deben utilizarse productos no agresivos con pH neutro. No mezclar piezas de diferentes lotes.

\* Midland mosaico 3D contains approximately 12'3 pieces/m<sup>2</sup>

\* Midland mosaico 3D contiene aproximadamente 12,3 piezas/m<sup>2</sup>

\* Midland mosaico 3D contiene aproximadamente 12,3 piezas/m<sup>2</sup>



**Midland gold corrugato lappato**  
29,75x59,55 cm - 11.71"x23.45"  
G-5401



**Midland silver corrugato lappato**  
29,75x59,55 cm - 11.71"x23.45"  
G-5401



**Midland copper corrugato lappato**  
29,75x59,55 cm - 11.71"x23.45"  
G-5431

\*\* For projects check technical information with our commercial network.

\*\*Per i progetti ottenere informazioni tecniche attraverso la nostra rete commerciale.

\*\* Para proyectos obtenga información técnica a través de nuestra red comercial.

## STEPS.GRADINI.PELDAÑOS

SIMPLE 

		natural
peldaño simple-120	(60x120 cm)	5519
peldaño simple	(60x60 cm)	5281
peldaño simple-60	(30x60 cm)	5171
peldaño simple-60 Corrugato	(30x60 cm)	5171
peldaño Ang	(60x60 cm)	5299
peldaño Ang	(30x60 cm)	5187
peldaño Ang Corrugato	(30x60 cm)	5187

GRADONE 















		natural
peldaño Gradone.-120	(60x120 cm)	5795
peldaño Gradone	(60x60 cm)	5559
peldaño Gradone-60	(30x60 cm)	5559
peldaño Grad.-60 Corrugato	(30x60 cm)	5559
peldaño Grad.Ang	(60x120 cm)	5815
peldaño Grad.Ang	(60x60 cm)	5609
peldaño Grad.Ang	(30x60 cm)	5609
peldaño Grad.Ang Corrug.	(30x60 cm)	5609



MIDLAND

Midland ivory natural 59,55x119,30 cm - Midland ivory mosaico 3D 28,5x28,5 cm

## TECHNICAL CHARACTERISTICS. CARATTERISTICHE TECNICHE. CARACTERÍSTICAS TÉCNICAS

MEASUREMENTS AND SURFACES APPEARANCE DIMENSIONI E ASPETTO SUPERFICIALE MEDIDAS Y ASPECTO SUPERFICIAL		STANDARD TEST METHOD METODO DELLA NORMA MÉTODO DE ENSAYO	STANDARD PRESCRIBED VALUES VALORE PRESCRITTO VALORES STANDARD NORMA	<b>MIDLAND</b> collection 7mm*
	<b>Length and width.</b> Lunghezza e larghezza. Longitud y anchura. Länge und Breite	ISO 10545-2	± 0,6% max.	± 0,2%
	<b>Orthogonality.</b> Ortogonalità. Ortogonalidad. Rechtwinkligkeit	ISO 10545-2	± 0,5% max.	± 0,2%
	<b>Straightness of sides.</b> Rettilinearità dei lati. Rectitud de lados. Kantengeradigkeit	ISO 10545-2	± 0,5% max.	± 0,2%
	<b>Surfaces flatness.</b> Planarità. Planitud. Ebenflächigkeit	ISO 10545-2	± 0,5% max.	± 0,2%
PHYSICAL PROPERTIES PROPIETÀ FISICHE PROPIEDADES FÍSICA				
	<b>Water absorption.</b> Assorbimento d' acqua. Absorción de agua. Wasseraufnahme	ISO 10545-3	≤ 0,5%	0,1%
	<b>Breaking strength, in N.</b> Carico di rottura, en N. Carga de rotura, en N. Bruchlast, in N	ISO 10545-4	≥ 700 N	1500 N
	<b>Modulus of rupture</b> Resistenza alla flessione. Resistencia a la flexión. Biegefestigkeit	ISO 10545-4	≥ 35 N/mm <sup>2</sup>	45 N/mm <sup>2</sup>
	<b>Resistance to deep abrasion.</b> Resistenza all' abrasione profonda. Resistencia a la abrasión profunda. Tiefverschleissbeständigkeit	ISO 10545-6	≤ 175 mm <sup>3</sup>	116 mm <sup>3</sup>
	<b>Resistance to thermal shock.</b> Resistenza agli sbalzi termici. Resistencia al choque térmico. Temperaturwechselbeständigkeit	ISO 10545-9	No surface defects should be visible Non deve presentare difetti visibili No debe presentar defectos superficiales visibles	Resistant. Resistente. Resistente
	<b>Frost resistance.</b> Resistenza al gelo. Resistencia a la helada. Frostbeständigkeit	ISO 10545-12	No surface defects or cracks should be visible Non deve presentare difetti visibili No debe presentar defectos ni grietas superficiales visibles	Frost Resistant Antighiaccio Resistente a la Helada
	<b>Coefficient of friction.</b> Resistenza allo scivolamento. Coeficiente de fricción. Rutschfestigkeit	DIN 51130 UNE-ENV 12633 DCOF - ANSIA 137.1	-	R9 (natural) R11 (corrugato) Clase 1** (natural) / Clase 3**/***(corrugato) >0.42 (natural)
	<b>Colour resistance to light.</b> Resistenza dei colori alla luce. Resistencia del color a la luz. Lichtbeständigkeit der Farben	DIN 51094	There should be no colour variations Non deve presentare difetti visibili No debe presentar variaciones de color	No alterations in colour and shine Non presenta alterazioni di colori e lucentezza No presenta variaciones de color y brillo
CHEMICAL PROPERTIES PROPIETÀ CHIMICHE PROPIEDADES QUÍMICAS				
	<b>Chemical resistance.</b> Resistenza agli agenti chimici. Resistencia química. Chemikalienbeständigkeit	ISO 10545-13	Resistance to household cleaning products and swimmingpools salts. Resistencia a productos domésticos y sales para piscinas.	Min. UB
	<b>Resistance to staining.</b> Resistenza alle macchie. Resistencia a las manchas. Fleckenbeständigkeit	ISO 10545-14	Declared Value Valor Declarado	5

\* The Land values are the average of different production consignments. For further detail information, please check with our commercial network.  
Los valores declarados son el promedio obtenido a través de ensayos de diferentes producciones. Para la obtención de una información detallada consultar a la red comercial.  
For projects check technical information with our commercial networks. / Para proyectos obtenga información técnica a través de nuestra red comercial.

\*\* Clase 1 - Tested in MIDLAND Gey Natural 30x60 (It depends on the consignment) Test realized in internal laboratory on September 2015.  
Clase 1 - Sobre el MIDLAND Gey Natural 30x60. Ensayo realizado en laboratorio interno en Septiembre 2015.  
Clase 3 - Tested in MIDLAND Gey Corrugato 30x60 (It depends on the consignment) Test realized in internal laboratory Grey Corrugato 30x60 on September 2015.  
Clase 3 - Sobre el MIDLAND Gey Corrugato 30x60. Ensayo realizado en laboratorio interno en Septiembre 2015.  
Clase 1 - Tested in MIDLAND Gey Natural 30x60 (It depends on the consignment) Test realized in internal laboratory Grey Corrugato 30x60 on October 2014.  
Clase 1 - Sobre el MIDLAND Gey Natural 30x60. Ensayo realizado en laboratorio

\*\*\* Dry Test, according to document DA DB-SUA/3 (Código Técnico de la Edificación) M° de Fomento. Test done in MIDLAND Grey Corrugato 30x60 on October 2015.  
Ensayo en seco, realizado según documento DA DB-SUA/3 (Código Técnico de la edificación) M° de Fomento, sobre el producto MIDLAND Grey Corrugato 30x60 a fecha octubre 2015



Midland ivory natural 59,55x119,30 cm Midland ivory mosaico 3D 28,5X28,5 cm

MIDLAND

## SPECIAL PIECES. PEZZI SPECIALI. PIEZAS ESPECIALES

## 3Dimensional

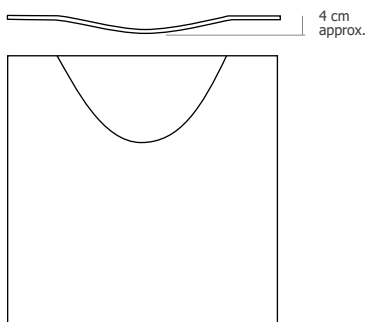

### BAG\*

59,55x119,30 cm / 59,55x59,55 cm / 29,75x59,55 cm

- Midland Bag 59,55x119,30 cm\* **G-5735**
- Midland Bag 59,55x59,55 cm\* **G-5449**
- Midland Bag 29,75x59,55 cm\* **G-5299**

\* Available in all colours from Midland collection.  
\* Disponible en todos los colores de la colección Midland.

This is a natural product made through a handmade process, therefore, its possible shade or size variations must be considered as typical features of the material and they will not be admitted in a claim.

Este es un producto natural fabricado artesanalmente, por lo que posibles variaciones de tono o dimensión deben considerarse propias del material y no será objeto de reclamación.