

GRES FINE PORCELLANATO

GEOBRICK

★★★★★  
**MONOCIBEC**<sup>®</sup>  
FINCIBEC GROUP

# GEOBRICK

Geobrick è la nuova, completa e versatile collezione di pavimenti in gres fine porcellanato che Monocibec dedica alla progettazione di tutti gli spazi interni ed esterni. Geobrick declina le sensazioni materiche e cromatiche del cotto tradizionale attraverso una finitura naturale, per creare ambienti eleganti e accoglienti, e una finitura grip a 9 e 20 mm di spessore, che favorisce l'utilizzo delle aree outdoor anche in condizioni climatiche non ideali, limitando il rischio di scivolamenti.

Geobrick is Monocibec's complete, versatile new collection of fine porcelain floor coverings for indoor and outdoor use. Geobrick expresses all the material and chromatic sensations of traditional terra cotta, with a natural finish for elegant, cosy spaces and a grip finish for outdoor use in 9 and 20 mm thickness, to prevent slipping even in inclement weather.

★★★★★  
**MONOCIBEC**<sup>®</sup>  
FINCIBEC GROUP

GRES FINE PORCELLANATO  
FINE PORCELAIN STONEWARE



GEOBRICK

# OUTDOOR

1 SUPERFICIE / SURFACE . GRIP / GRIP  
2 BORDI / EDGES . NATURALE / NATURAL RETTIFICATO / RECTIFIED  
6 FORMATI / SIZES

## 10 mm

## MAJOR 20 mm



BRUGES

50x50 cm - 20"x20"  
25x50 cm - 10"x20"  
25x25 cm - 10"x10"  
6,2x25 cm - 2,4"x10"

80x80 cm - 31,5"x31,5"  
60x60 cm - 24"x24"



VOLTERRA

50x50 cm - 20"x20"  
25x50 cm - 10"x20"  
25x25 cm - 10"x10"  
6,2x25 cm - 2,4"x10"

80x80 cm - 31,5"x31,5"  
60x60 cm - 24"x24"



SIENA

50x50 cm - 20"x20"  
25x50 cm - 10"x20"  
25x25 cm - 10"x10"  
6,2x25 cm - 2,4"x10"

80x80 cm - 31,5"x31,5"  
60x60 cm - 24"x24"



CANOSSA

50x50 cm - 20"x20"  
25x50 cm - 10"x20"  
25x25 cm - 10"x10"  
6,2x25 cm - 2,4"x10"

80x80 cm - 31,5"x31,5"  
60x60 cm - 24"x24"



GRONINGEN

6,2x25 cm - 2,4"x10"

80x80 cm - 31,5"x31,5"  
60x60 cm - 24"x24"

GEOBRICK

# INDOOR

1 SUPERFICIE / SURFACE . NATURALE / NATURAL  
1 BORDO / EDGE . RETTIFICATO / RECTIFIED  
3 FORMATI / SIZES

## 9 mm



BRUGES

60x60 cm - 24"x24"  
30x60 cm - 12"x24"  
30x30 cm - 12"x12"



VOLTERRA

60x60 cm - 24"x24"  
30x60 cm - 12"x24"  
30x30 cm - 12"x12"



SIENA

60x60 cm - 24"x24"  
30x60 cm - 12"x24"  
30x30 cm - 12"x12"



CANOSSA

60x60 cm - 24"x24"  
30x60 cm - 12"x24"  
30x30 cm - 12"x12"



GRONINGEN

60x60 cm - 24"x24"  
30x60 cm - 12"x24"  
30x30 cm - 12"x12"

★★★★★  
**MONOCIBEC**  
FINCIBEC GROUP

GRES FINE PORCELLANATO  
FINE PORCELAIN STONEWARE



# BRUGES

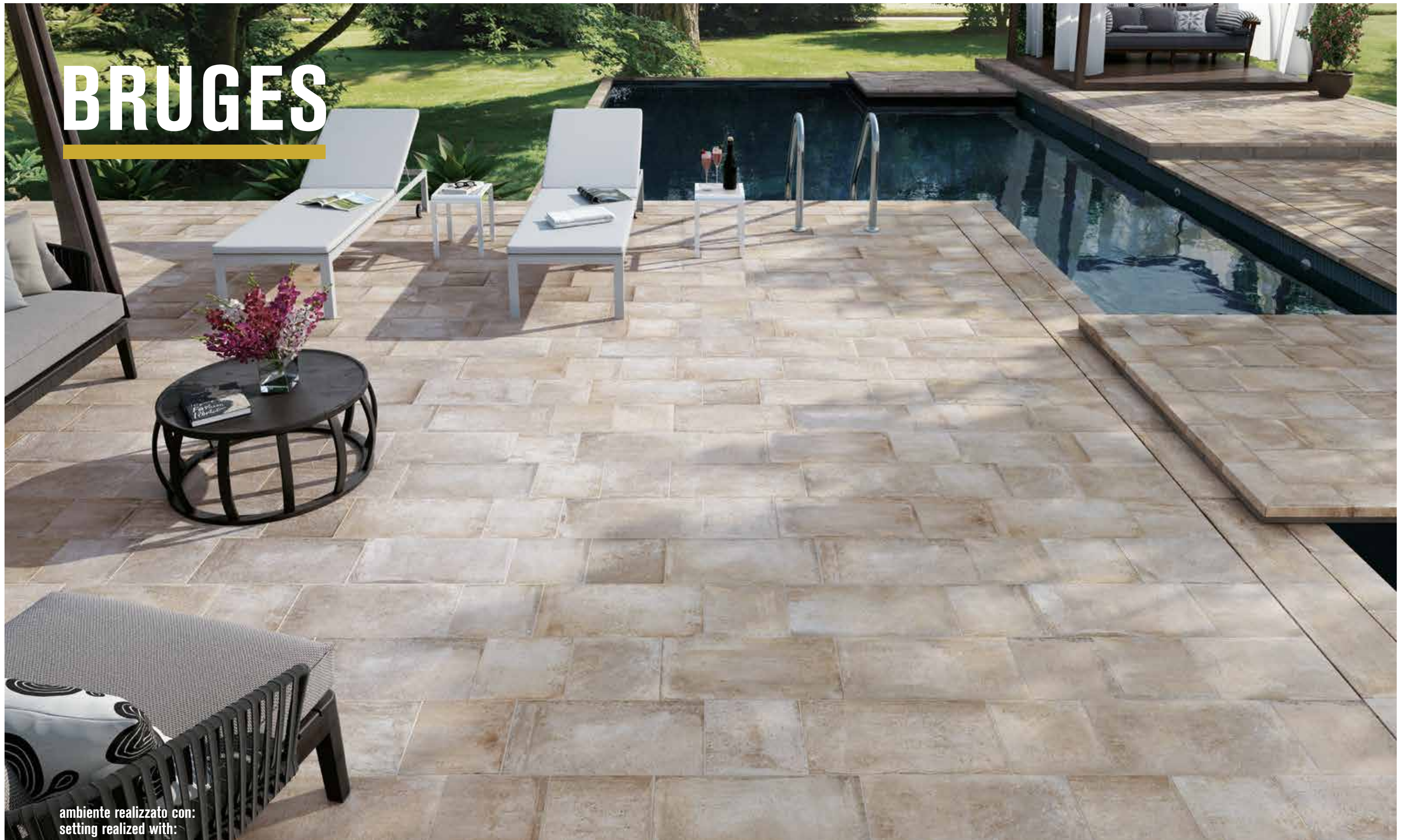

ambiente realizzato con:  
setting realized with:

**bruges 25x50 grip**  
**bruges 25x25 grip**  
**pezzi speciali pools&wellness / pools&wellness special pieces**











# VOLTERRA



ambiente realizzato con:  
setting realized with:

**volterra 25x50 grip**  
**volterra mattoncino 6,2x25 grip**



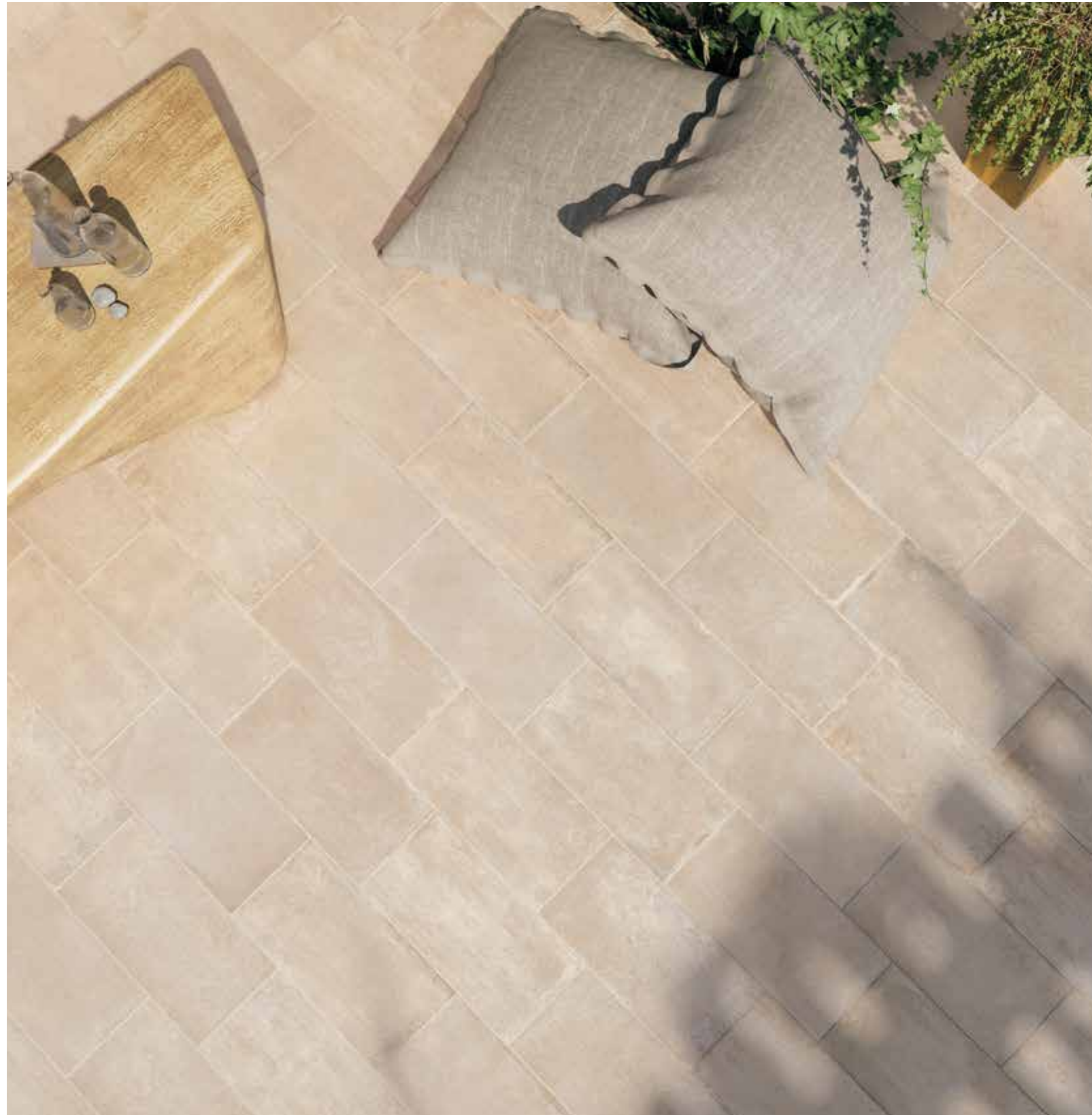







# SIENA



ambiente realizzato con:  
setting realized with:

**siena 50x50 grip**  
**siena 25x50 grip**  
**siena mattoncino 6,2x25 grip**







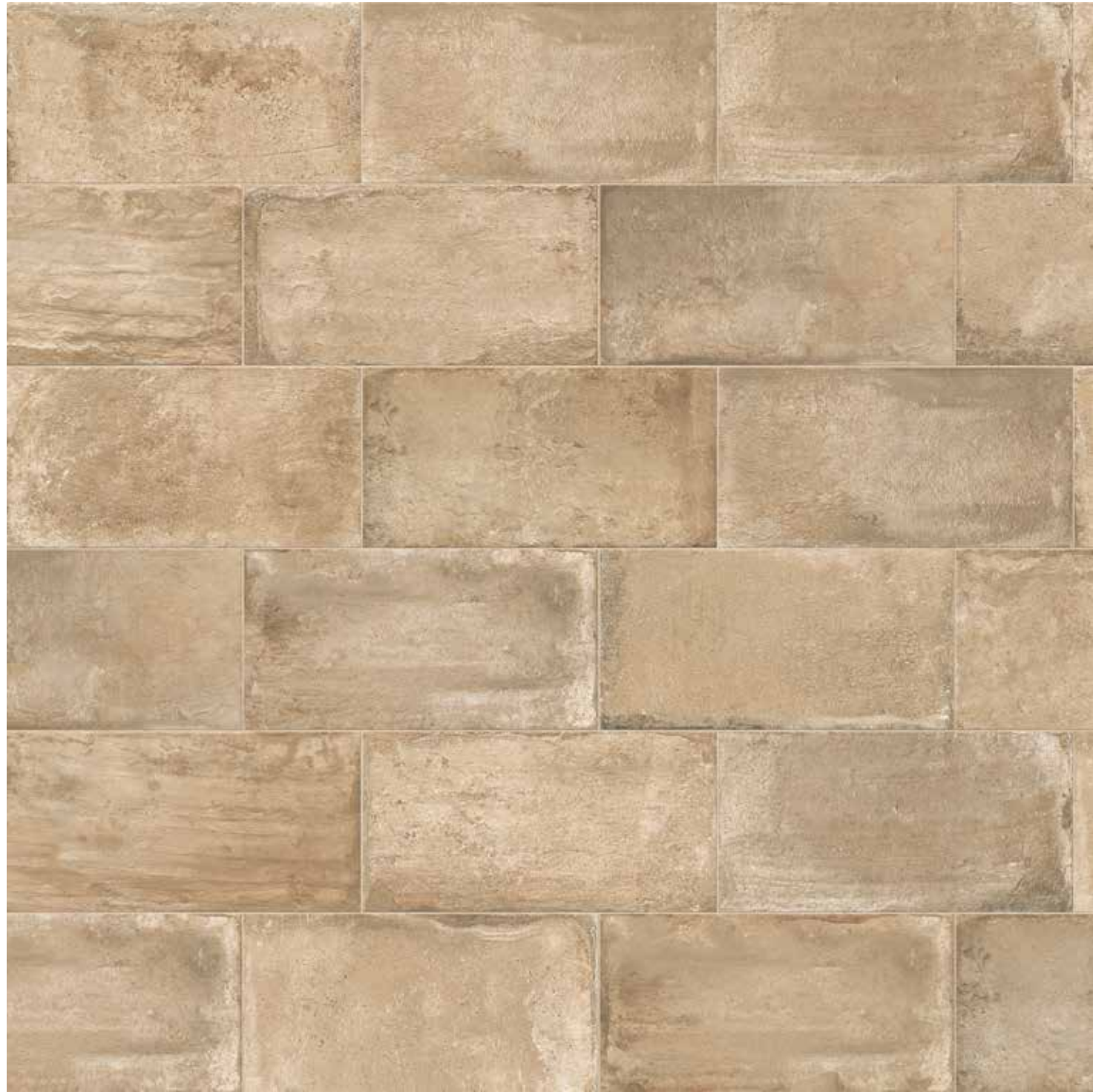



# CANOSSA



ambiente realizzato con:  
setting realized with:

**canossa 25x50 grip**  
**canossa mattoncino 6,2x25 grip**



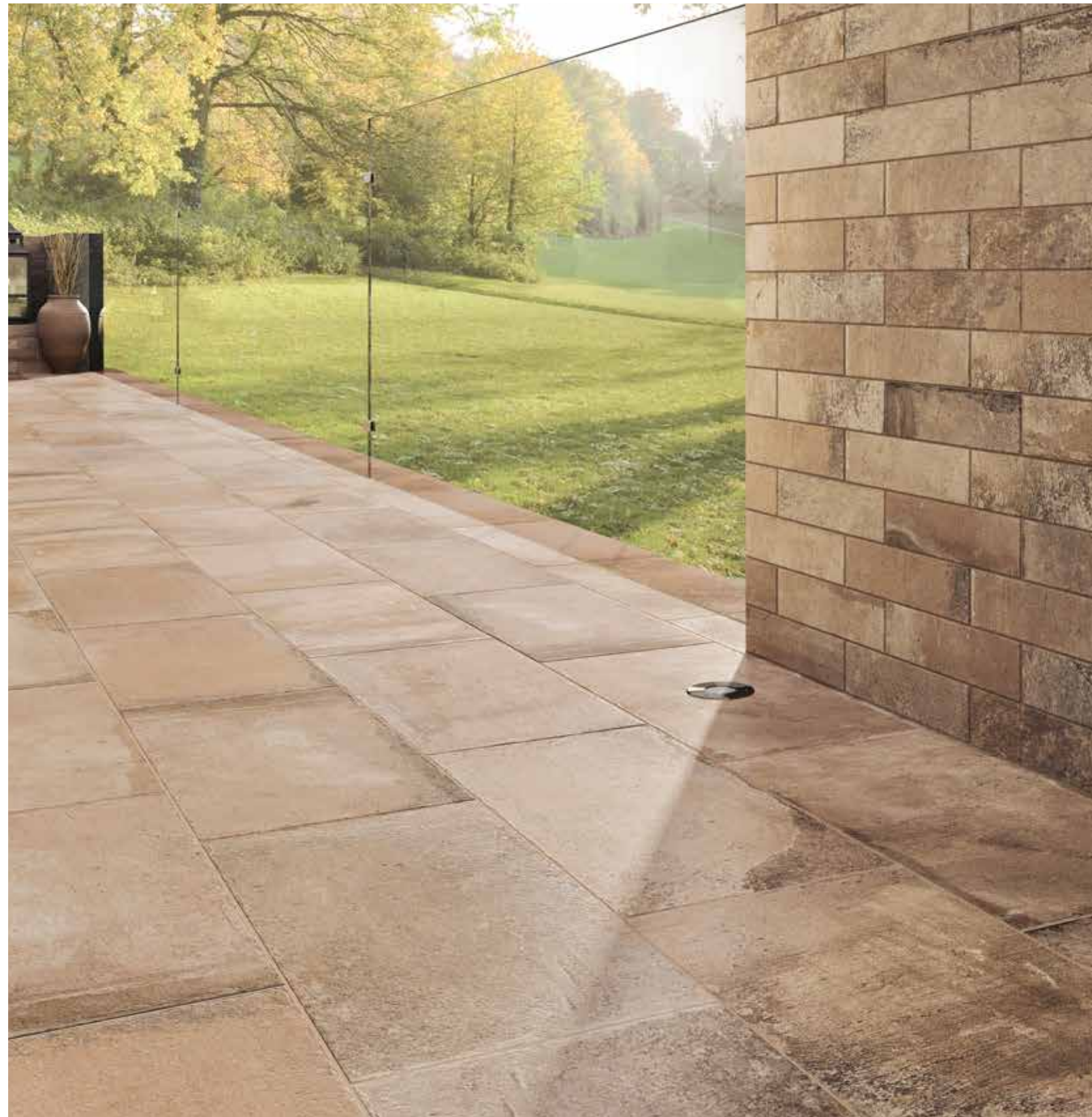

24

# CANOSSA



25

★★★★★  
**MONOCIBEC**  
FINCIBEC GROUP  
GRES FINE PORCELLANATO  
FINE PORCELAIN STONEWARE

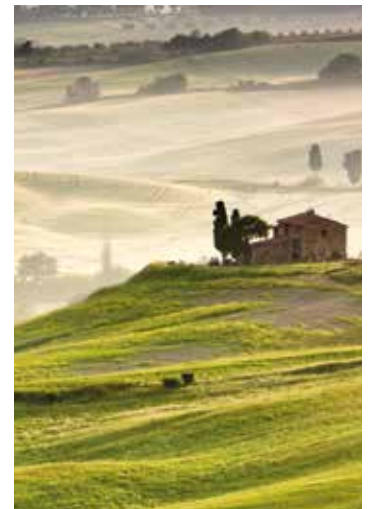



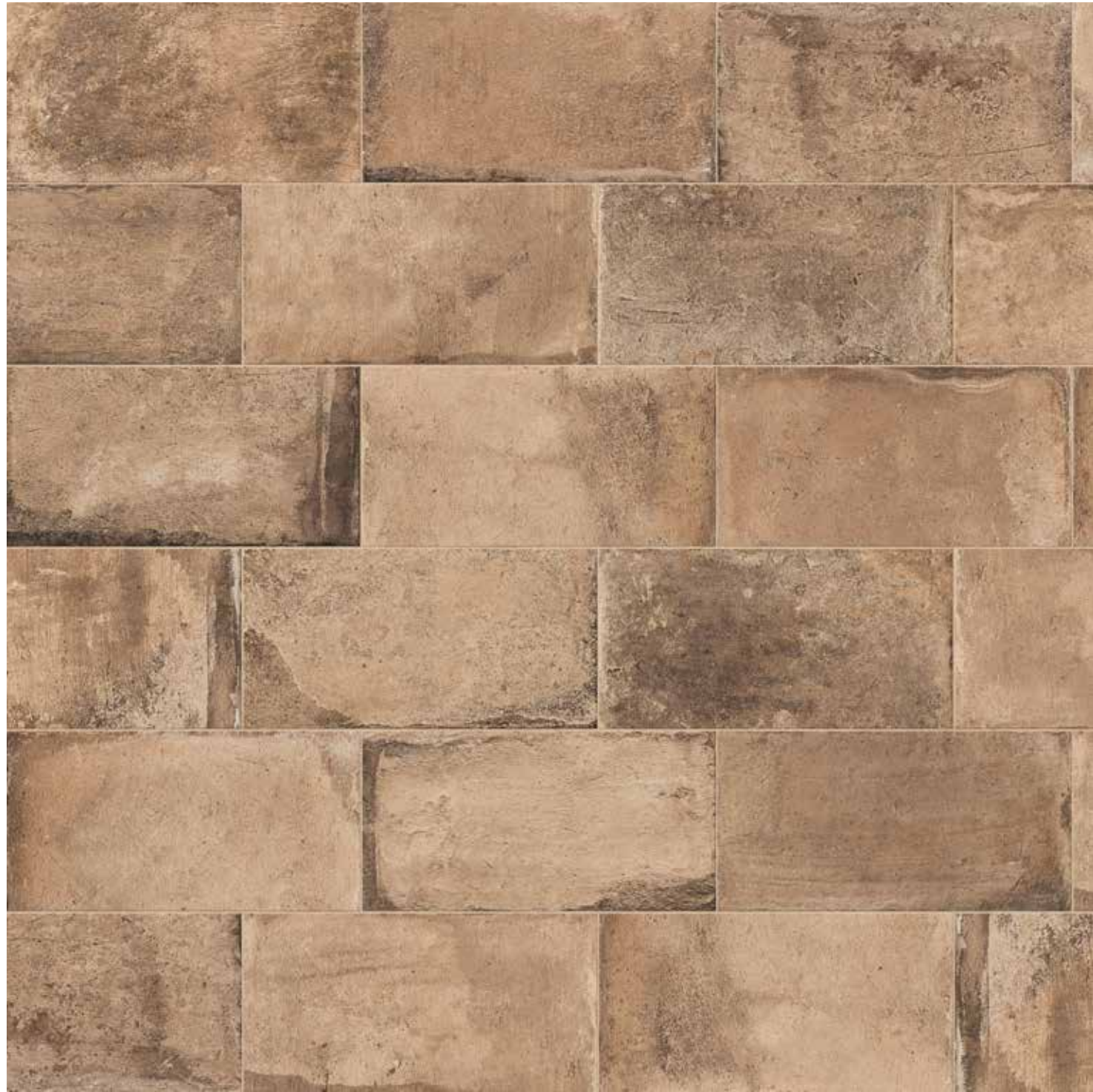



# GRONINGEN



ambiente realizzato con:  
setting realized with:

**groningen 60x60 naturale**



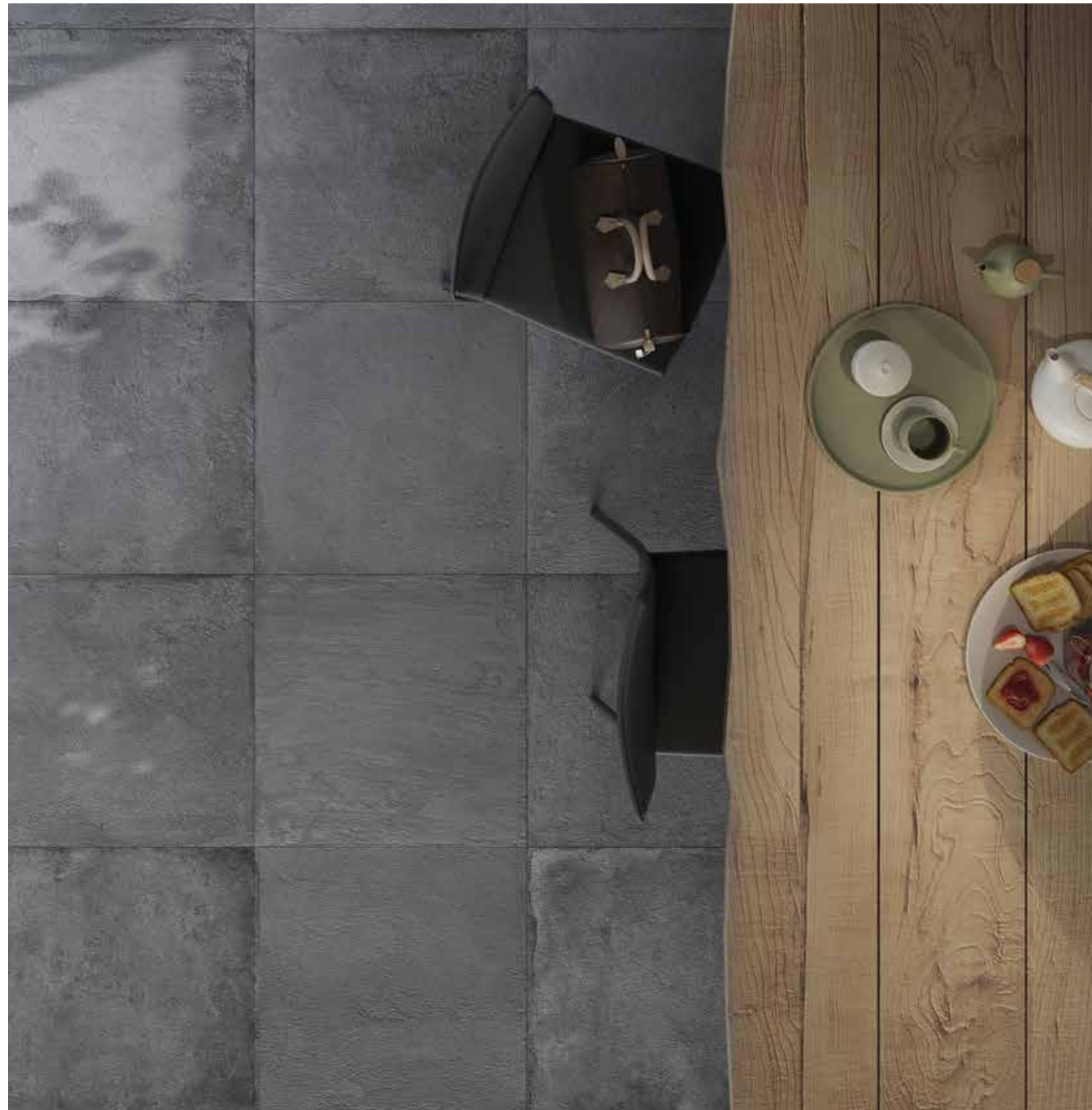







# OUTDOOR



**BRUGES**    **VOLTERRA**    **SIENA**    **CANOSSA**

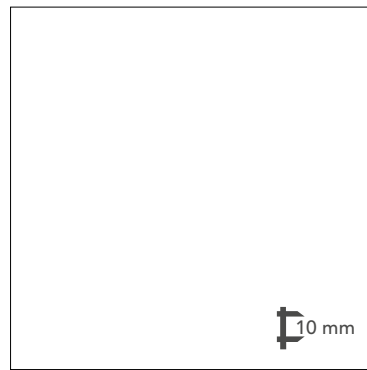

50x50 . 20"x20" Grip  
94846 Bruges  
94845 Volterra  
94844 Siena  
94843 Canossa

■ 83



25x50 . 10"x20" Grip  
94850 Bruges  
94849 Volterra  
94848 Siena  
94847 Canossa

■ 83



25x25 . 10"x10" Grip  
94854 Bruges  
94853 Volterra  
94852 Siena  
94851 Canossa

■ 83

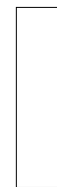

Mattoncino 6,2x25 . 2,4"x10" Grip  
96148 Bruges  
96151 Volterra  
96150 Siena  
96149 Canossa  
101867 Groningen

■ 141

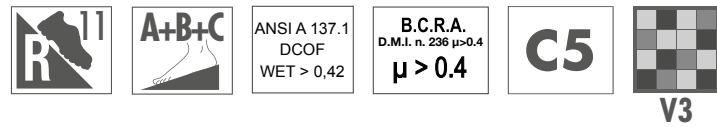

**BRUGES**    **VOLTERRA**    **SIENA**    **CANOSSA**    **GRONINGEN**



80x80 . 31,5"x31,5" Nat. rett.  
107666 Bruges    107665 Canossa  
107668 Volterra    107669 Groningen  
107667 Siena

■ 168



60x60 . 24"x24" Nat. rett.  
107651 Bruges    107650 Canossa  
107653 Volterra    107654 Groningen  
107652 Siena

■ 151

# INDOOR



**BRUGES**    **VOLTERRA**    **SIENA**    **CANOSSA**    **GRONINGEN**



60x60 . 24"x24" Nat. rett.  
100687 Bruges  
100690 Volterra  
100689 Siena  
100688 Canossa  
100686 Groningen

■ 105

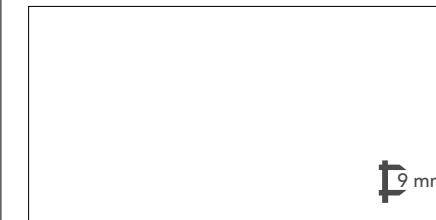

30x60 . 12"x24" Nat. rett.  
100692 Bruges  
100695 Volterra  
100694 Siena  
100693 Canossa  
100691 Groningen

■ 89



30x30 . 12"x12" Nat. rett.  
100697 Bruges  
100700 Volterra  
100699 Siena  
100698 Canossa  
100696 Groningen

■ 109

GEOBRICK

★★★★★  
**MONOCIBEC**  
FINCIBEC GROUP

**GRES FINE PORCELLANATO**  
**FINE PORCELAIN STONEWARE**



# OUTDOOR

PEZZI SPECIALI . SPECIAL PIECES

10 mm



8x50 . 3"x20"  
BATTISCOPA  
GRIP ● 14

25x50 . 10"x20"  
GRADINO  
GRIP ● 43

15x30x4 . 6"x12"x1,6"  
ELEMENTO ELLE  
MONOLITICO GRIP ● 31

PEZZI SPECIALI . SPECIAL PIECES

20 mm

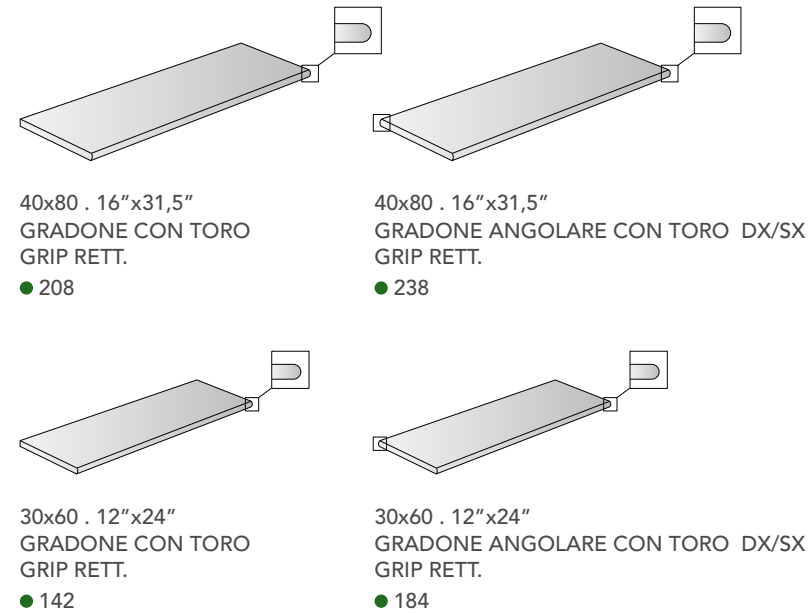

40x80 . 16"x31,5"  
GRADONE CON TORO  
GRIP RETT. ● 208

40x80 . 16"x31,5"  
GRADONE ANGOLARE CON TORO DX/SX  
GRIP RETT. ● 238

30x60 . 12"x24"  
GRADONE CON TORO  
GRIP RETT. ● 142

30x60 . 12"x24"  
GRADONE ANGOLARE CON TORO DX/SX  
GRIP RETT. ● 184



GRES FINE PORCELLANATO  
FINE PORCELAIN STONEWARE

# INDOOR

PEZZI SPECIALI . SPECIAL PIECES

9 mm

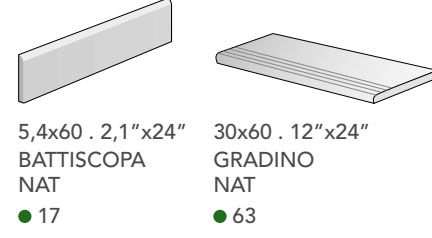

5,4x60 . 2,1"x24"  
BATTISCOPA  
NAT ● 17

30x60 . 12"x24"  
GRADINO  
NAT ● 63

PEZZI SPECIALI POOLS&WELLNESS . POOLS&WELLNESS SPECIAL PIECES

10 mm

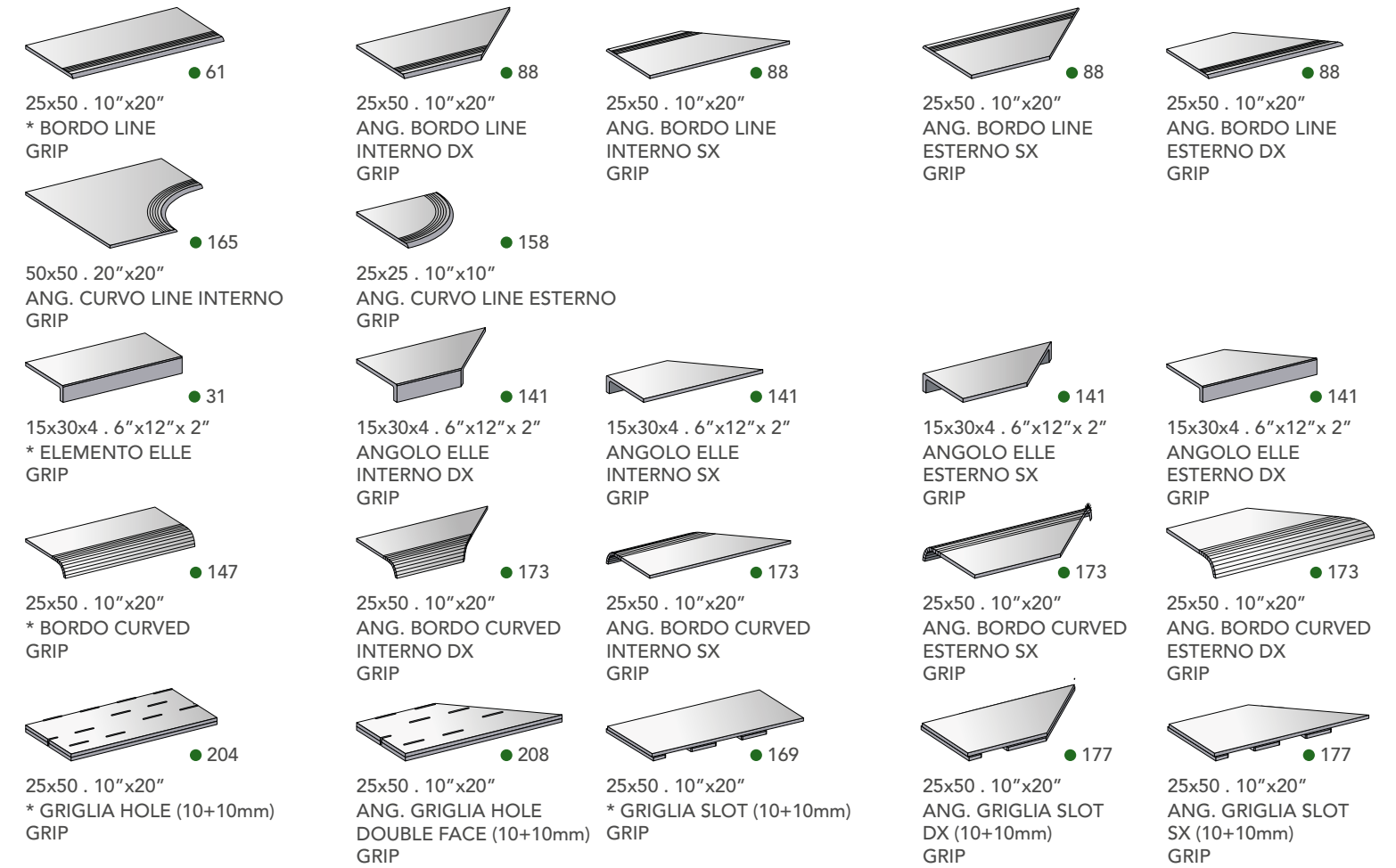

25x50 . 10"x20"  
\* BORDO LINE  
GRIP ● 61

25x50 . 10"x20"  
ANG. BORDO LINE  
INTERNO DX  
GRIP ● 88

25x50 . 10"x20"  
ANG. BORDO LINE  
INTERNO SX  
GRIP ● 88

25x50 . 10"x20"  
ANG. BORDO LINE  
ESTERNO SX  
GRIP ● 88

25x50 . 10"x20"  
ANG. BORDO LINE  
ESTERNO DX  
GRIP ● 88

50x50 . 20"x20"  
ANG. CURVO LINE INTERNO  
GRIP ● 165

25x25 . 10"x10"  
ANG. CURVO LINE ESTERNO  
GRIP ● 158

15x30x4 . 6"x12"x 2"  
\* ELEMENTO ELLE  
GRIP ● 31

15x30x4 . 6"x12"x 2"  
ANGOLO ELLE  
INTERNO DX  
GRIP ● 141

15x30x4 . 6"x12"x 2"  
ANGOLO ELLE  
INTERNO SX  
GRIP ● 141

15x30x4 . 6"x12"x 2"  
ANGOLO ELLE  
ESTERNO SX  
GRIP ● 141

15x30x4 . 6"x12"x 2"  
ANGOLO ELLE  
ESTERNO DX  
GRIP ● 141

25x50 . 10"x20"  
\* BORDO CURVED  
GRIP ● 147

25x50 . 10"x20"  
ANG. BORDO CURVED  
INTERNO DX  
GRIP ● 173

25x50 . 10"x20"  
ANG. BORDO CURVED  
INTERNO SX  
GRIP ● 173

25x50 . 10"x20"  
ANG. BORDO CURVED  
ESTERNO SX  
GRIP ● 173

25x50 . 10"x20"  
ANG. BORDO CURVED  
ESTERNO DX  
GRIP ● 173

25x50 . 10"x20"  
\* GRIGLIA HOLE (10+10mm)  
GRIP ● 204

25x50 . 10"x20"  
ANG. GRIGLIA HOLE  
DOUBLE FACE (10+10mm)  
GRIP ● 208

25x50 . 10"x20"  
\* GRIGLIA SLOT (10+10mm)  
GRIP ● 169

25x50 . 10"x20"  
ANG. GRIGLIA SLOT  
DX (10+10mm)  
GRIP ● 177

25x50 . 10"x20"  
ANG. GRIGLIA SLOT  
SX (10+10mm)  
GRIP ● 177

20 mm

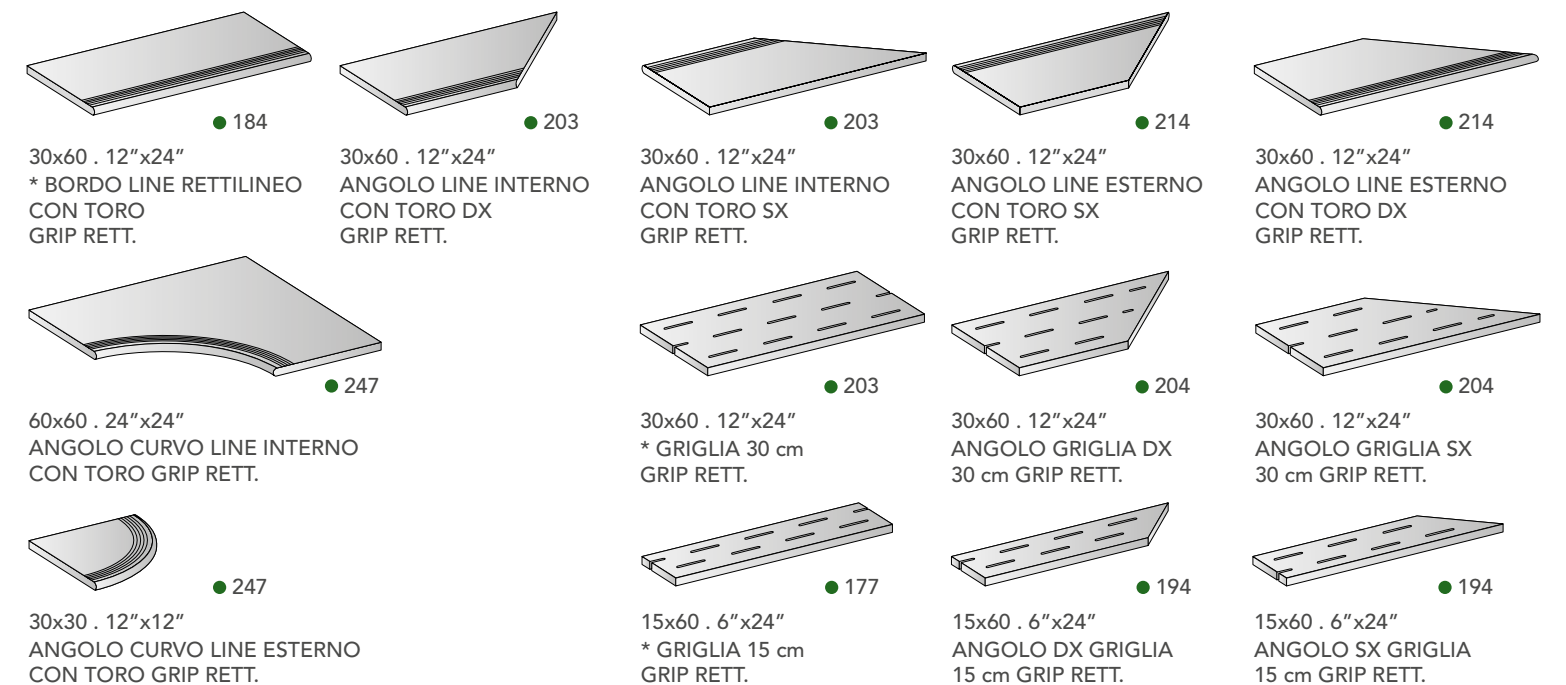

30x60 . 12"x24"  
\* BORDO LINE RETTILINEO  
CON TORO  
GRIP RETT. ● 184

30x60 . 12"x24"  
ANGOLO LINE INTERNO  
CON TORO DX  
GRIP RETT. ● 203

30x60 . 12"x24"  
ANGOLO LINE INTERNO  
CON TORO SX  
GRIP RETT. ● 203

30x60 . 12"x24"  
ANGOLO LINE ESTERNO  
CON TORO SX  
GRIP RETT. ● 214

30x60 . 12"x24"  
ANGOLO LINE ESTERNO  
CON TORO DX  
GRIP RETT. ● 214

60x60 . 24"x24"  
ANGOLO CURVO LINE INTERNO  
CON TORO GRIP RETT. ● 247

30x60 . 12"x24"  
\* GRIGLIA 30 cm  
GRIP RETT. ● 203

30x60 . 12"x24"  
ANGOLO GRIGLIA DX  
30 cm GRIP RETT. ● 204

30x60 . 12"x24"  
ANGOLO GRIGLIA SX  
30 cm GRIP RETT. ● 204

30x30 . 12"x12"  
ANGOLO CURVO LINE ESTERNO  
CON TORO GRIP RETT. ● 247

15x60 . 6"x24"  
\* GRIGLIA 15 cm  
GRIP RETT. ● 177

15x60 . 6"x24"  
ANGOLO DX GRIGLIA  
15 cm GRIP RETT. ● 194

15x60 . 6"x24"  
ANGOLO SX GRIGLIA  
15 cm GRIP RETT. ● 194



\*Prezzo per ordine minimo di 20 pz. Per quantitativi inferiori, rivolgersi agli uffici commerciali per una quantificazione specifica.  
\*Price for a minimum order of 20 items. For smaller volumes, please contact our commercial office for a specific quote.



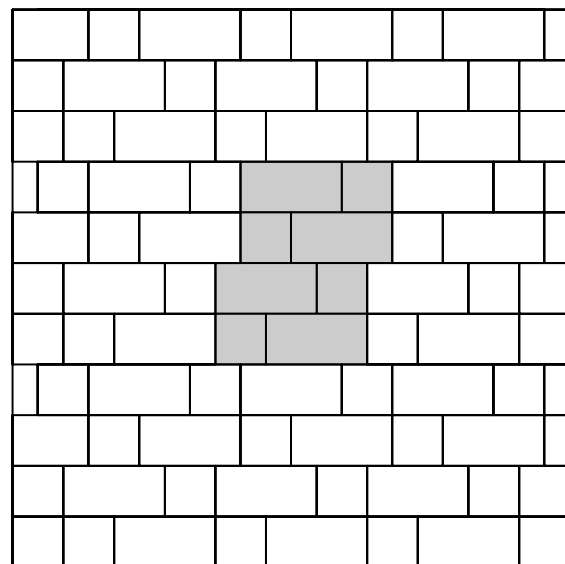

FORMATI - SIZES	% MQ
25x50 . 10"x20"	66,7 %
25x25 . 10"x10"	33,3 %
30x60 . 12"x24"	66,7 %
30x30 . 12"x12"	33,3 %

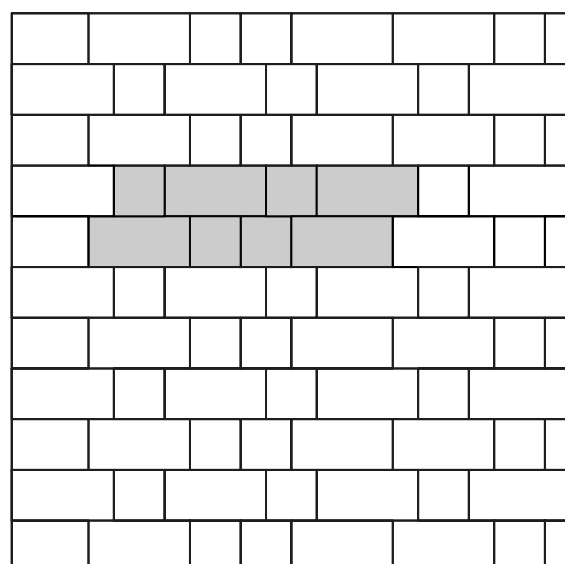

FORMATI - SIZES	% MQ
25x50 . 10"x20"	66,7 %
25x25 . 10"x10"	33,3 %
30x60 . 12"x24"	66,7 %
30x30 . 12"x12"	33,3 %

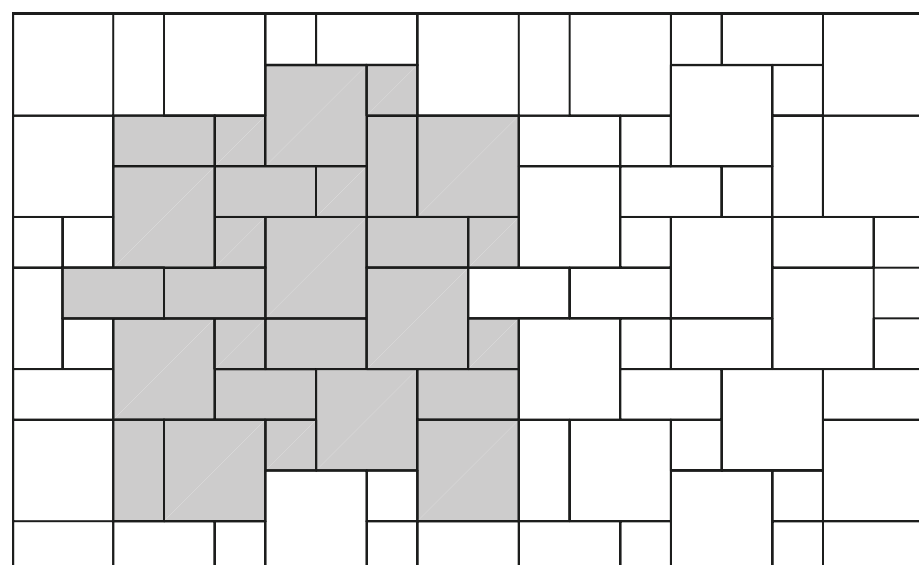

FORMATI - SIZES	% MQ
50x50 . 20"x20"	56,3 %
25x50 . 10"x20"	31,3 %
25x25 . 10"x10"	12,5 %
60x60 . 24"x24"	56,3 %
30x60 . 12"x24"	31,3 %
30x30 . 12"x12"	12,5 %

**CATEGORIE D'IMPIEGO . USE CLASSES**

- C1** Piastrelle da pavimento consigliate per calpestio leggero  
Floor tiles recommended for light pounding
- C2** Piastrelle da pavimento consigliate per calpestio medio-leggero  
Floor tiles recommended for medium-light pounding
- C3** Piastrelle da pavimento consigliate per calpestio medio  
Floor tiles recommended for medium pounding
- C4** Piastrelle da pavimento consigliate per calpestio medio-pesante  
Floor tiles recommended for medium-heavy pounding
- C5** Piastrelle da pavimento consigliate per calpestio intenso  
Floor tiles recommended for heavy uses

**VARIAZIONI CROMATICHE . COLOURS VARIATIONS**



-  **V1** Aspetto uniforme  
Even appearance
-  **V2** Lieve variazione  
Light variation
-  **V3** Media variazione  
Medium variation
-  **V4** Intensa variazione  
Strong variation

È indispensabile all'atto della posa, prelevare le piastrelle da più confezioni.

It is necessary to take the tiles from several different boxes when laying them.



**OUTDOOR**

**IMBALLI . PACKAGING**

	50x50	25x50	25x25	6,2x25	80x80 MAJOR	60x60 MAJOR
 Pc.	4	9	17	66	1	2
M <sup>2</sup>	1	1,125	1,063	1,023	0,64	0,72
Kg	21	23	21	22,5	29	35
 Colli boxes	39	54	66	36	40	30
M <sup>2</sup>	39	60,75	70,158	36,828	25,6	21,6
Kg	819	1.242	1.386	810	1160	1050

**INDOOR**

**IMBALLI . PACKAGING**

	60x60	30x60	30x30
 Pc.	3	6	13
M <sup>2</sup>	1,08	1,08	1,17
Kg	22,5	22	22
 Colli boxes	40	48	48
M <sup>2</sup>	43,2	51,84	56,16
Kg	900	1.056	1.056

**NOTE . NOTES**

I prodotti possono essere modificati da Fincibec senza preavviso, respingendo ogni responsabilità su possibili danni diretti o indiretti causati da potenziali modifiche. Fincibec reserves the right to modify its products without prior notice and cannot be held liable for direct or indirect damage caused by such modifications.

Verificare sempre la correttezza delle informazioni e dei dati relativi a codici, imballaggi e pesi, consultando il listino prezzi in vigore.

Always refer to the price list in force to ensure correct information and data on codes, packaging, and weight.



















Le tonalità dei colori riportate nel catalogo sono indicative. The colours shades, reported on the catalogue, are indicative.



# CARATTERISTICHE TECNICHE / GRES FINE PORCELLANATO COLORATO IN MASSA

TECHNICAL SPECIFICATIONS / FULL-BODY COLOURED PORCELAIN STONEWARE - TECHNISCHE EIGENSCHAFTEN / DURCHGEFÄRBTES FEINSTEINZEUG - CARACTÉRISTIQUES TECHNIQUES / GRÈS FIN CÉRAME COLORÉ EN MASSE - CARACTERÍSTICAS TÉCNICAS / GRES FINO PORCELÁNICO TENIDO EN MASA - ТЕХНИЧЕСКИЕ ХАРАКТЕРИСТИКИ / МЕЛКОЗЕРНИСТЫЙ КЕРАМОГРАНИТ, ОКРАШЕННЫЙ В МАССЕ

STANDARDS : UNI EN 14411 ANNEX G - Bla / UNI EN ISO 13006 ANNEX G - Bla

CARATTERISTICHE TECNICHE TECHNICAL DATA TECHNISCHE DATEN CARACTÉRISTIQUES TECHNIQUES CARACTERÍSTICAS TÉCNICAS ТЕХНИЧЕСКИЕ ХАРАКТЕРИСТИКИ	TIPO DI PROVA STANDARD OF TEST NORME DU TEST TESTNORM TIPO DE PRUEBA ТИП ТЕСТА	VALORI PRESCRITTI DALLE NORME INTERNATIONAL STANDARDS INTERNATIONALE NORMWERTE VALEURS PRÉVUES PAR LES NORMES VALORES PREVISTOS POR LAS NORMAS ПРЕДУКАТОРНЫЕ СТАНДАРТОМ REQUIREMENTS FOR NOMINAL SIZE-N		VALORE MEDIO MONOCIBEC MONOCIBECAVERAGEWALUE MONOCIBECMITTELWERT VALEUR MOYEN MONOCIBEC VALOR MEDIO MONOCIBEC СРЕДНЕЕ ЗНАЧЕНИЕ MONOCIBEC	
		7 cm ≤ N ≤ 15 cm	N ≥ 15 cm	GRIP	NAT
 <b>LATI</b> SIDES - SEITEN COTES - CANTOS РАЗМЕРЫ СТОРОН	EN ISO 10545-2	± 0,9 mm	± 0,6% (± 2,0 mm)	CONFORME COMPLYING - ERFÜLLT CONFORME - CONFORME COOBTETCTBYET	
 <b>SPESSORE</b> THICKNESS - DICKE ÉPAISSEUR - ESPESOR ТОЛЩИНА	EN ISO 10545-2	± 0,5 mm	± 5,0% (± 0,5 mm)	CONFORME COMPLYING - ERFÜLLT CONFORME - CONFORME COOBTETCTBYET	
 <b>RETTILINEITÀ DEGLI SPIGOLI</b> STRAIGHTNESS OF SIDES - GERAUUNGKEIT DER KANTEN RECTITUDE DES ARÊTES - RECTITUDE DE LOS CANTOS - КОСОУТОЛЬНОСТЬ	EN ISO 10545-2	± 0,75 mm	± 0,5% (± 1,5 mm)	CONFORME COMPLYING - ERFÜLLT CONFORME - CONFORME COOBTETCTBYET	
 <b>ORTOGONALITÀ</b> RECTANGULARITY - RECHTWINKLIGKEIT PERPENDICULARITÉ - ORTOGONALIDAD КРИБИЗНА СТОРОН	EN ISO 10545-2	± 0,75 mm	± 0,5% (± 2 mm)	CONFORME COMPLYING - ERFÜLLT CONFORME - CONFORME COOBTETCTBYET	
 <b>PLANARITÀ</b> SURFACE FLATNESS - EBENFLÄCHIGKEIT PLANEITE DE SURFACE - PLANEIDAD КРИБИЗНА ЛИЦЕВОЙ ПОВЕРХНОСТИ	EN ISO 10545-2	± 0,75 mm	± 0,5% (± 2,0 mm)	CONFORME COMPLYING - ERFÜLLT CONFORME - CONFORME COOBTETCTBYET	
 <b>ASSORBIMENTO D'ACQUA</b> WATER ABSORPTION - WASSERAUFNAHME ABSORPTION D'EAU - ABSORCIÓN DE AGUA ВОДПОПОЩЕНІЕ	EN ISO 10545-3	≤ 0,5 %		≤ 0,1 %	
 <b>RESISTENZA ALLA FLESSIONE</b> FLEXION RESISTANCE - BIEGEFESTIGKEIT RESISTANCE A LA FLEXION - RESISTENCIA A LA FLEXIÓN ПРЕДЕЛ ПРОЧНОСТИ ПРИ ИЗГИБЕ	EN ISO 10545-4	S ≥ 1.300 N R ≥ 35 N/mm <sup>2</sup>		CONFORME COMPLYING - ERFÜLLT CONFORME - CONFORME COOBTETCTBYET	
 <b>RESISTENZA ALL'URTO</b> IMPACT RESISTANCE - STOSSFESTIGKEIT RESISTANCE AUX CHOCS - RESISTENCIA A LOS GOLPES УДАРНОСТОЙКОСТЬ	EN ISO 10545-5	VALORE DICHIARATO DECLARED VALUE - ANGEGBENER WERT VALEUR DÉCLARÉE - VALOR DECLARADO - ЗАЯВЛЕННОЕ ЗНАЧЕНИЕ		> 0,80	
 <b>RESISTENZA ALL'ABRASIONE</b> ABRASION RESISTANCE - ABRIBFESTIGKEIT RESISTANCE À L'ABRASION - RESISTENCIA A LA ABRASIÓN ПРОЧНОСТЬ НА ИСТИРАНИЕ	EN ISO 10545-6	≤ 175 mm <sup>3</sup>		CONFORME COMPLYING - ERFÜLLT CONFORME - CONFORME COOBTETCTBYET	
 <b>COEFFICIENTE DI DILATAZIONE TERMICA LINEARE</b> COEFFICIENT OF LINEAR THERMAL EXPANSION - LINEARER WÄRMEAUSENDNUNGSKOEFFIZIENT COEFFICIENT DE DILATION THERMIQUE LINEAIRE - COEFFICIENTE DE DILATACIÓN TÉRMICA LINEAL КОЭФИЦИЕНТ ЛИНЕЙНОГО ТЕРМИЧЕСКОГО РАСТЯЖЕНИЯ	EN ISO 10545-8	VALORE DICHIARATO DECLARED VALUE - ANGEGBENER WERT VALEUR DÉCLARÉE - VALOR DECLARADO - ЗАЯВЛЕННОЕ ЗНАЧЕНИЕ		α = 6,7x10 <sup>-6</sup> /°C	
 <b>RESISTENZA AGLI SBALZI TERMICI</b> RESISTANCE TO THERMAL SHOCKS - BESTÄNDIGKEIT GEGEN TEMPERATURSCHWANKUNGEN RESISTANCE AUX CHOCS THERMIQUES - RESISTENCIA A LOS CHOQUES TÉRMICOS СТОЙКОСТЬ К ПЕРЕПАДАМ ТЕМПЕРАТУРЫ	EN ISO 10545-9	TEST SUPERATO SECONDO EN ISO 10545-1 TEST PASSED ACCORDING TO - TEST BESTANDEN NACH TEXTE DÉPASSÉ SELON - PRUEBA SUPERADA SEGÚN ИСПЫТАНИЕ ПРОЙДЕНО В СООТВЕТСТВИИ С		NESSUN DANNO NO DAMAGE - KEIN SCHADEN AUCUN DOMMAGE - NINGUN DANO БЕЗ ПОВРЕЖДЕНИЙ	
 <b>DILATAZIONE ALL'UMIDITÀ (IN MMM)</b> MOISTURE EXPANSION (IN MMM) - FEUCHTIGKEITSBEDINGTE AUSDEHNUNG (IN MMM) DILATATION À L'HUMIDITÉ (EN MMM) - DILATACIÓN CON LA HUMEDAD (EN MMM) ВЛАЖНОСТНОЕ РАСТЯЖЕНИЕ (В MMM)	EN ISO 10545-10	VALORE DICHIARATO DECLARED VALUE - ANGEGBENER WERT VALEUR DÉCLARÉE - VALOR DECLARADO - ЗАЯВЛЕННОЕ ЗНАЧЕНИЕ		MAX 0,1 mm / m	
 <b>RESISTENZA AL GELO</b> FROST RESISTANCE - FROSTBESTÄNDIGKEIT RESISTANCE AU GEL - RESISTENCIA AL HIELO МОРОЗОСТОЙКОСТЬ	EN ISO 10545-12	TEST SUPERATO SECONDO EN ISO 10545-1 TEST PASSED ACCORDING TO - TEST BESTANDEN NACH TEXTE DÉPASSÉ SELON - PRUEBA SUPERADA SEGÚN ИСПЫТАНИЕ ПРОЙДЕНО В СООТВЕТСТВИИ С		NESSUN DANNO NO DAMAGE - KEIN SCHADEN AUCUN DOMMAGE - NINGUN DANO БЕЗ ПОВРЕЖДЕНИЙ	
 <b>RESISTENZA AI PRODOTTI CHIMICI USO DOMESTICO E ADDITIVI PER PISCINA</b> RESISTANCE TO HOUSEHOLD AND SWIMMING POOL CHEMICAL PRODUCTS - BESTÄNDIGKEIT GEGEN HAUSHALTSREINIGMITTEL UND ZUSATZSTOFFE FÜR SWIMMINGPOOLS - RESISTANCE AUX PRODUITS CHIMIQUES USAGE DOMESTIQUE ET ADITIFS POUR PISCINE - RESISTENCIA A LOS PRODUCTOS QUÍMICOS DE USO DOMÉSTICO Y ADITIVOS PARA PISCINA - СТОЙКОСТЬ К ДЕЙСТВИЮ ВЫСОКИХ ХИМИЧЕСКИХ СРЕДСТВ, ДОБАВКАМ В БАССЕЙНЫ	EN ISO 10545-13	B MIN		CONFORME COMPLYING - ERFÜLLT CONFORME - CONFORME COOBTETCTBYET	
 <b>RESISTENZA A BASSE CONCENTRAZIONI DI ACIDI E ALCALI</b> RESISTANCE TO LOW CONCENTRATIONS OF ACIDS AND ALKALI - BESTÄNDIGKEIT BEI NIEDRIGEN KONZENTRATIONEN VON SÄUREN UND LAUGEN - RESISTANCE À BASSES CONCENTRATIONS D'ACIDES ET ALCALIS - RESISTENCIA A BAJAS CONCENTRACIONES DE ÁCIDOS Y ÁLCALIS - СТОЙКОСТЬ К ДЕЙСТВИЮ НИЗКИХ КОНЦЕНТРАЦИЙ КИСЛОТ И ЩЕЛОЧЕЙ	EN ISO 10545-13	VALORE DICHIARATO DECLARED VALUE - ANGEGBENER WERT VALEUR DÉCLARÉE - VALOR DECLARADO - ЗАЯВЛЕННОЕ ЗНАЧЕНИЕ		CONFORME COMPLYING - ERFÜLLT CONFORME - CONFORME COOBTETCTBYET	
 <b>RESISTENZA AD ALTE CONCENTRAZIONI DI ACIDI E ALCALI</b> RESISTANCE TO HIGH CONCENTRATIONS OF ACIDS AND ALKALI - BESTÄNDIGKEIT BEI HOHEN KONZENTRATIONEN VON SÄUREN UND LAUGEN - RESISTANCE À HAUTES CONCENTRATIONS D'ACIDES ET ALCALIS - RESISTENCIA A ALTAS CONCENTRACIONES DE ÁCIDOS Y ÁLCALIS - СТОЙКОСТЬ К ДЕЙСТВИЮ ВЫСОКИХ КОНЦЕНТРАЦИЙ КИСЛОТ И ЩЕЛОЧЕЙ	EN ISO 10545-13	VALORE DICHIARATO DECLARED VALUE - ANGEGBENER WERT VALEUR DÉCLARÉE - VALOR DECLARADO - ЗАЯВЛЕННОЕ ЗНАЧЕНИЕ		CONFORME COMPLYING - ERFÜLLT CONFORME - CONFORME COOBTETCTBYET	
 <b>RESISTENZA ALLE MACCHIE</b> RESISTANCE TO STAINS - FLECKENBESTÄNDIGKEIT RESISTANCE AUX TACHES - RESISTENCIA A LAS MANCHAS УСТОЙЧИВОСТЬ К ПЯТНООБРАЗОВАНИЮ	EN ISO 10545-14	VALORE DICHIARATO DECLARED VALUE - ANGEGBENER WERT VALEUR DÉCLARÉE - VALOR DECLARADO - ЗАЯВЛЕННОЕ ЗНАЧЕНИЕ		CONFORME COMPLYING - ERFÜLLT CONFORME - CONFORME COOBTETCTBYET	
 <b>CESSIONE DI PIOMBO E CADMIO</b> LEAD AND CADMIUM DISCHARGE - ABGABE VON BLEI UND CADMIUM PERTE DE PLOMB ET CADMIUM - CESIÓN DE PLOMO Y CADMIO Выделение свинца и кадмия	EN ISO 10545-15	VALORE DICHIARATO DECLARED VALUE - ANGEGBENER WERT VALEUR DÉCLARÉE - VALOR DECLARADO - ЗАЯВЛЕННОЕ ЗНАЧЕНИЕ		< LIMITE DI RILEVAMENTO < THAN INSTRUMENT LIMIT - UNMESSBARES WERT < LIMITE DE L'INSTRUMENT < LIMITE DEL INSTRUMENTO < НА ПРЕДЕЛЕ ОПРЕДЕЛЯЕМОСТИ	
 <b>SCIVOLISITÀ</b> SKID RESISTANCE - RUTSCHWERT GLISSANCE - ADHERENCIA СКОЛЬЗКОСТЬ	DM 236/89 BCRA	> 0,40		> 0,40 GRIP	> 0,40 NAT
	ANSI A 137.1	WET DCOF > 0,42		> 0,42 GRIP	> 0,42 NAT
	DIN 51130	-		R11 GRIP	R10 NAT
	DIN 51097	-		A+B+C GRIP	-

PER I CERTIFICATI SPECIFICI, E VALORI PUNTUALI, CONTATTARE FINOCIBEC SPA - FOR SPECIFIC CERTIFICATES AND DATA, CONTACT FINOCIBEC S.P.A. - FÜR SPEZIELLE ZERTIFIKATE UND PUNKTWERTE, FINOCIBEC S.P.A. KONTAKTIEREN - POUR LES CERTIFICATS SPÉCIFIQUES ET LES VALEURS PONCTUELLES, CONTACTER FINOCIBEC S.P.A. - PARA LOS CERTIFICADOS ESPECÍFICOS Y LOS VALORES CONCRETOS, CONTACTE CON FINOCIBEC S.P.A. - ВО ВОПРОСАХ СПЕЦИАЛЬНЫХ СЕРТИФИКАТОВ И ПОКАЗАТЕЛЕЙ СВЯЖИТЕСЬ С FINOCIBEC SPA.

GEOBRICK

★★★★★  
**MONOCIBEC**  
FINOCIBEC GROUP

GRES FINE PORCELLANATO  
FINE PORCELAIN STONEWARE





MONOCIBEC  
Via Valle d'Aosta, 47 - 41049 - Sassuolo (Mo) Italy  
Tel. +39 0536 861300  
Fax Italia +39 0536 861400  
Fax Export Dept. +39 0536 861450  
info@monocibec.it  
www.monocibec.it

Fincibec S.p.A.  
Sede legale:  
Via Valle d'Aosta, 47 - 41049 - Sassuolo (Mo) Italy  
Gruppo Fire S.R.L.

---

Fincibec USA Inc.  
240 Kent Ave K3/B36 Brooklyn N.Y. 11249 USA  
Ph.+1 917-969-4916  
info@fincibecusa.com



FINCIBEC S.p.A. socio di :

