

Unigestone

5 COLOURS

5 SIZES

3 SURFACES

A collection inspired by the aesthetics of different stones, granites and marbles, skilfully mixed together liven up the style of every environment, whether residential or commercial.

Una collezione ispirata all'estetica di pietre, graniti e marmi differenti sapientemente miscelati tra di loro per muovere con carattere lo stile di ogni ambiente, residenziale o commerciale.

Eine am aussehen verschiedener und auf gelungene Weise miteinander kombinierter Steine, Granite und Marmorarten inspirierte Kollektion. Bringt stilvoll Bewegung und Charakter in jeden Gewerbe- oder Wohnraum.

Une collection qui puise son inspiration a l'esthétique de la pierre. Plusieurs types de granits et de marbres savamment mélangés apportent une note authentique de caractère à tout espace de vie, à usage privatif ou commercial.

Unigestone

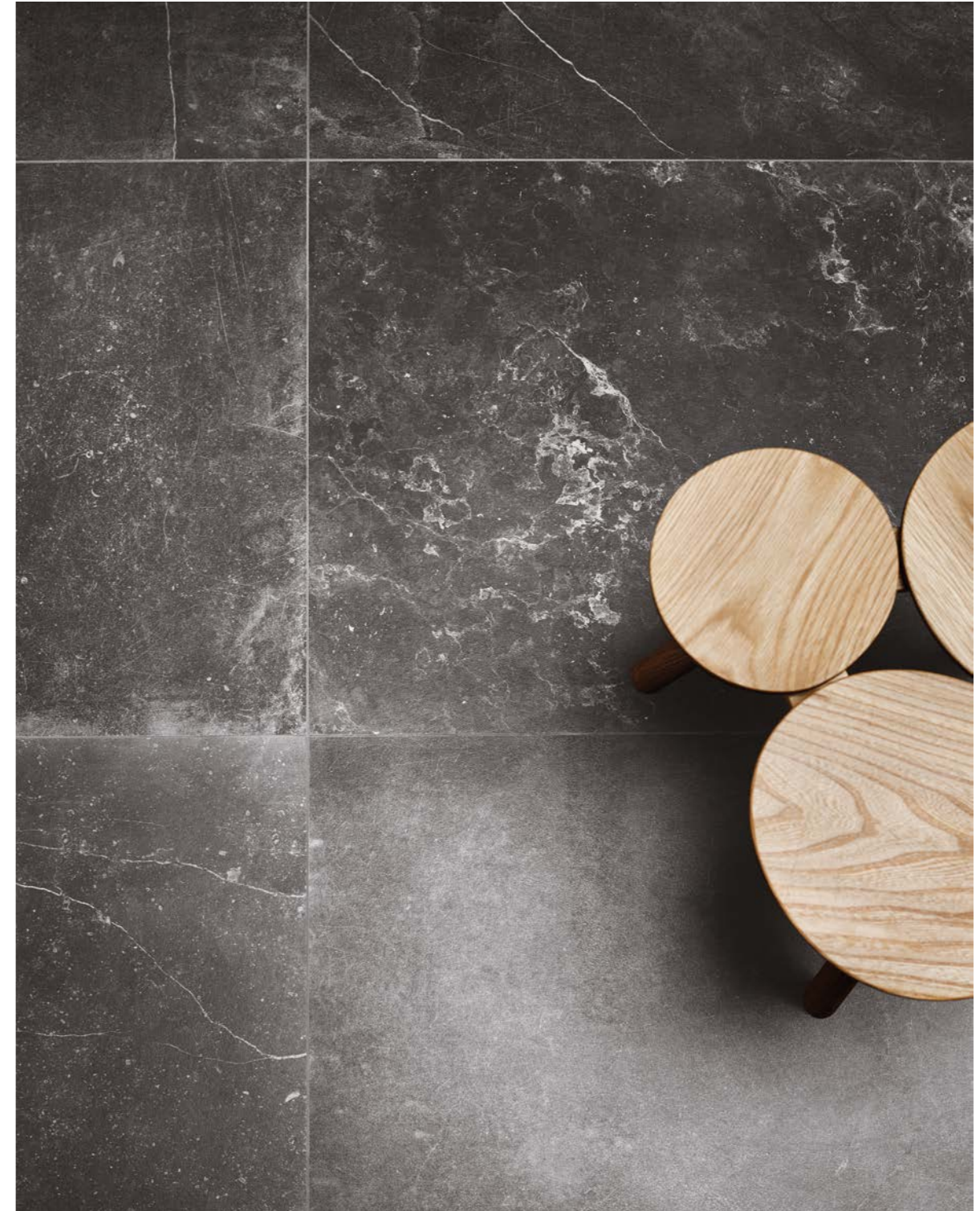

Spazi Residenziali
Residential Spaces

P. 5

Spazi Pubblici
Public Areas

P. 23

Informazioni Tecniche
Technical Information

P. 39

La superficie della materia è caratterizzata da uno stonalizzo grafico ben bilanciato da un tono di fondo morbido ed omogeneo per un risultato finale molto equilibrato nella sua variabilità. Disponibile in cinque varianti cromatiche in finitura naturale e levigata è ideale per rivestire ambienti interni ed esterni ad alto impatto emozionale.

The material surface is characterized by well-balanced graphic colour and by a soft and uniform colour background for an end result which is very stable in its variability. Available in five different colours in natural and polished finish, it is perfect for covering interior and outdoor environments with high emotional impact.

Die Oberfläche des Materials ist durch grafische Nuancierungen geprägt, die durch eine weiche und gleichmässige Grundnote ausgeglichen werden. Das sorgt für einen trotz der Variabilität harmonischen Gesamteindruck. In fünf Farbvarianten jeweils mit Oberfläche natur und Poliert erhältlich. Ideal zur Verkleidung von Innen- und Außenbereichen von hoher Emotionaler Wirkung.

La surface de la matière est caractérisée par un dénuancement graphique bien équilibré, sur un fond au ton doux et homogène, pour aboutir à une variabilité parfaitement maîtrisée. Disponible en cinq variantes chromatiques, finition naturelle et polie, c'est un revêtement idéal pour l'intérieur et l'extérieur à fort impact émotionnel.

Spazi Residenziali

Residential Spaces
Wohnanlagen
Espaces Résidentiels

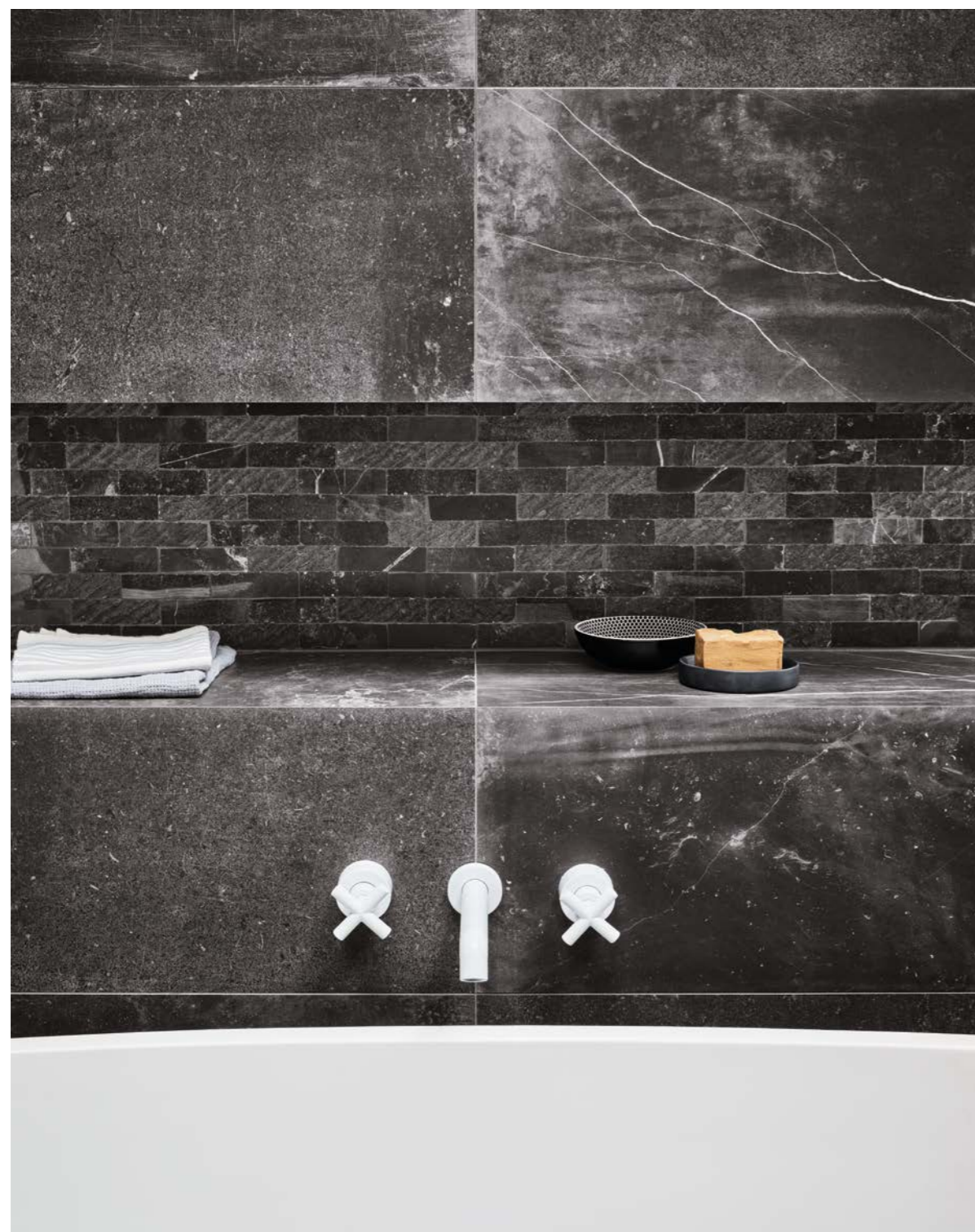

COLORI / COLOURS

AMBIENTI / AMBIENT

PAGINA / PAGE

Nite	Bathroom	6
Titanium	Bedroom	10
Sand	Kitchen	14
Silver	Entrance	18
Silk	Living	20

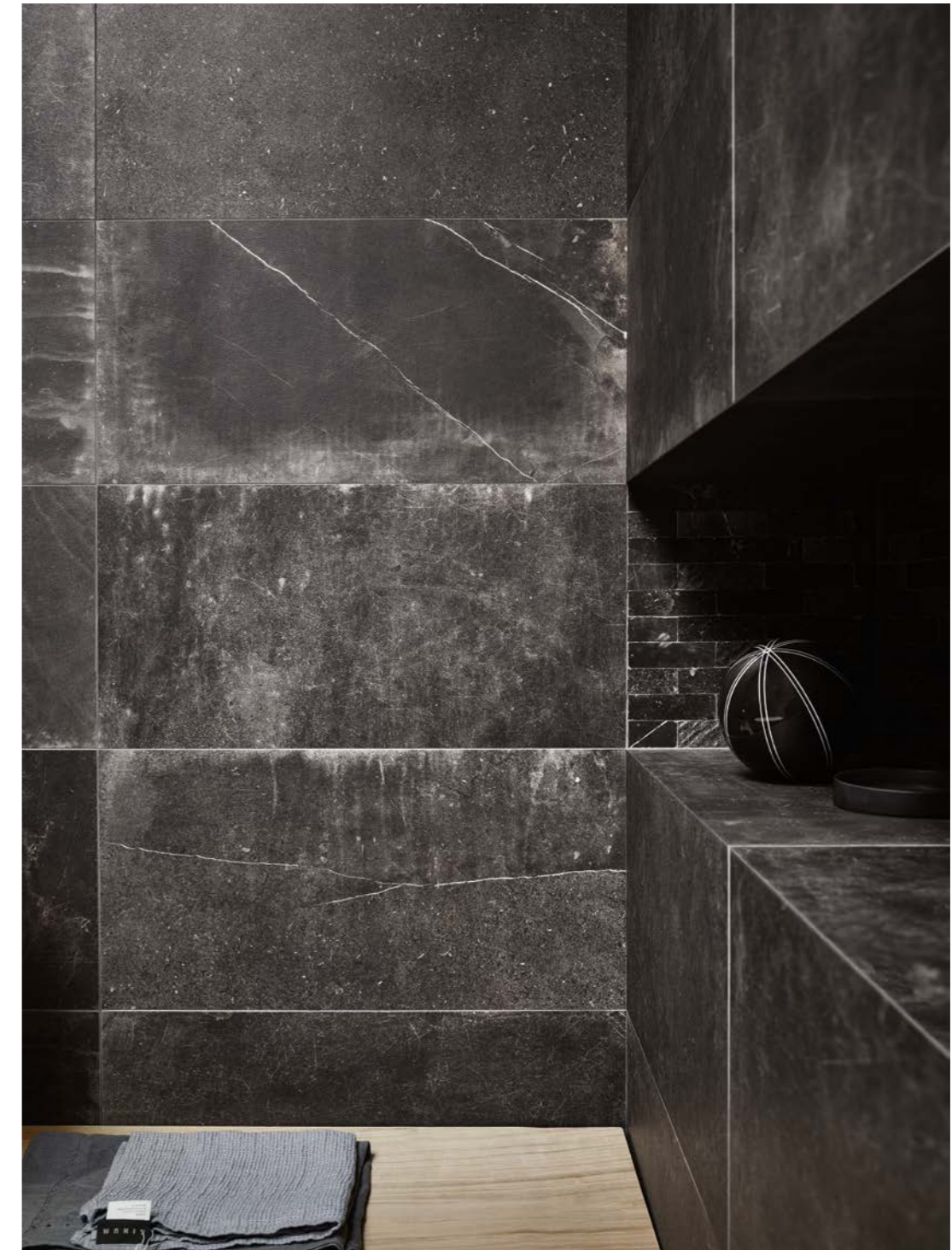











Silver

The result is a tile which, depending on how it is interpreted, can be used in environments characterised by various styles, from classic to contemporary and eclectic.

Ein Erzeugnis, das je nach Auslegung für verschiedene Stilarten von Klassik bis Modern bis hin zum Eklektizismus geeignet ist.

En fonction de l'interprétation qu'on lui donne, ce produit pourra être décliné sur une grande variété de styles, du classique au contemporain en passant par l'éclectique.

Un prodotto che a seconda dell'interpretazione può essere declinato in varie tipologie di stile, dal classico al contemporaneo, all'eclettico.

30x60 - 12"x24" Naturale Rettificato





Spazi Pubblici

Public Areas
Öffentliche Räumlichkeiten
Espaces Publics



COLORI / COLOURS

AMBIENTI / AMBIENT

PAGINA / PAGE

Silk	Shop	24
Sand	Hall	28
Silver	Airport Lounge	30
Titanium	Boutique Hotel	34
Nite	Restaurant	36

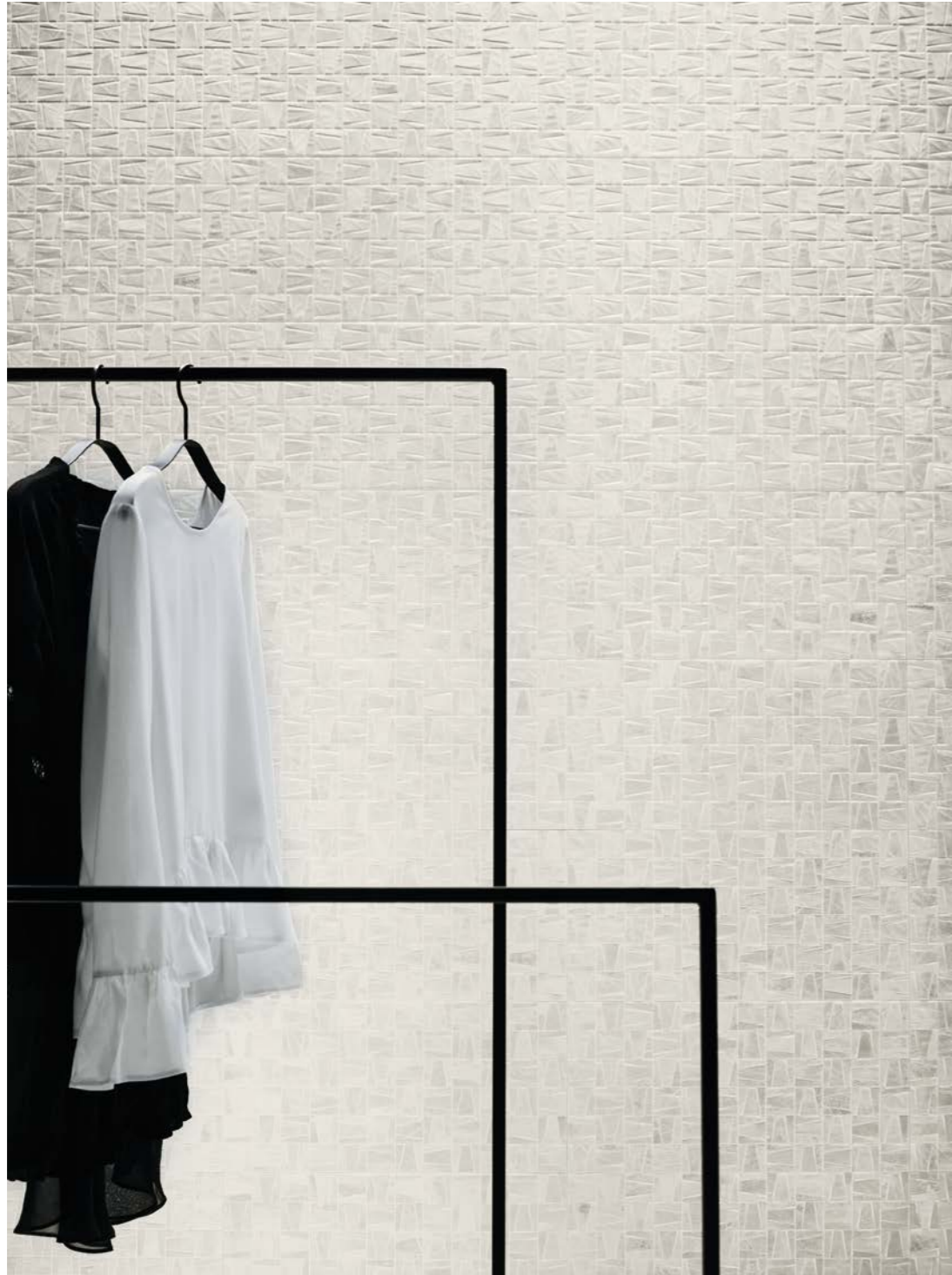



Sand

It is extremely “transversal”, thanks to its flexibility and the fact that it can be matched and paired with materials of different kinds, “adaptable” due to the possibilities it offers when it comes to interpreting different styles and “versatile” as it can be used to meet a wide variety of design requirements.

Sehr “zweckübergreifend” dank seiner Vielseitigkeit, Kombinationen und Zusammenstellungen mit verschiedenartigen Materialien; “mannigfaltig”, weil es sich mit unterschiedlichen Stilen interpretieren lässt; “vielseitig” für die jeweiligen Entwurfsbedürfnisse.

Sa polyvalence le rend vraiment “transversal”; il peut être associé à des matériaux de nature différente, s’adapte à des styles divers et se plie aux contraintes de la conception.

Altamente “trasversale”, grazie alla sua flessibilità, abbinamenti e accostamenti con materiali di natura differente, “duttile” per la possibilità che offre di interpretazione con stili differenti, “versatile” alle differenti necessità di progettazione.

80×80 - 31½”×31½” Levigato Rettificato







Titanium

It is an intrinsically sustainable material yet at the same time flaunts a highly sophisticated charm thanks to the technology used to create it.

Das Material ist dank seiner Beschaffenheit nachhaltig und seiner Fertigungstechnologie gleichzeitig auch reich an ausgefeilter Eleganz.

De par sa nature, c'est un matériel écologique qui possède néanmoins un charme très sophistiqué dû à la technologie adoptée pour sa réalisation.

Un materiale sostenibile per la sua stessa natura ed al contempo ricco di un fascino altamente sofisticato grazie alla tecnologia utilizzata per la sua realizzazione.

60x60 - 24"x24" Naturale Rettificato



Uniquestone
Public Areas

Nite

Unigestone is the result of ongoing research and experimentation process. This has generated a product that closely resembles the spontaneous, irregular graphic look of the natural materials to which it is inspired.

Unigestone ist das Ergebnis ständiger Recherchen und Versuche, die ein Produkt hervorbrachten, das eine große Ähnlichkeit mit dem spontanen, ungleichmäßigen Aussehen der natürlichen Materialien hat, an denen es inspiriert ist.

Unigestone est le fruit d'une recherche ininterrompue. Celle-ci a donné vie à un produit très proche de la représentation graphique, spontanée et irrégulière, des matériaux naturels dont il s'inspire.

Unigestone è il frutto di una ricerca di continua sperimentazione che ha generato un prodotto molto vicino alla spontanea ed irregolare rappresentazione grafica dei materiali naturali cui si ispira.

80x80 - 31½"x31½" Levigato Rettificato



Unigestone
Public Areas

Informazioni Tecniche

5

Colori
Colours
Farben
Couleurs

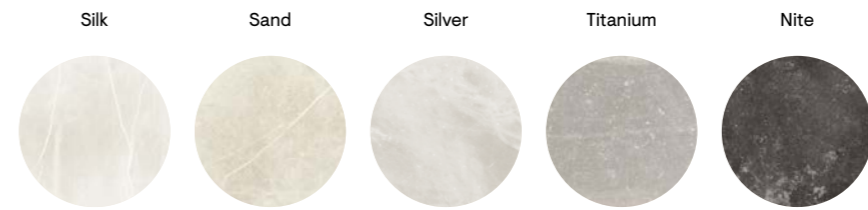

5

Formati
Sizes
Formate
Formats

60×119,5 24"×47½"	*80×80 31½"×31½"	60×60 24"×24"	30×60 12"×24"	10×53 4"×20"
----------------------	---------------------	------------------	------------------	-----------------

2

Spessori
Thickness
Stärke
Epaisseur

±9,5 ±10,5

3

Superfici
Surfaces
Oberflächen
Surfaces

Naturale Levigato Bocciardato

4

Strutture 3D
3D structures
Strukturen
Décorations en relief



i

Effetto Pietra
Stone Look
Natursteinoptik
Effet Pierre

Rivestimento
Wall Tiles
Wandfliesen
Revêtement

Pavimento
Floor Tiles
Bodenfliesen
Sol

Gres fine porcellanato ad impasto colorato
Coloured-body fine porcelain stoneware
Feinsteinzeug aus farbiger Masse
Grès cérame fin à pâte colorée

Tecnologia digitale
Digital technology
Digital technologie
Technologie numérique

*Attenzione: verificare in fase di ordine il codice e l'imballo (80×80)
*Note: In the ordering phase please check code and packaging (80×80)
*Bitteachten: Beim Bestellen bitte die Kodenummer und die Verpackung kontrollieren (80×80)
*Attention : Merci de vérifier emballage et la référence au moment de la commande (80×80)



Gres fine porcellanato ad impasto colorato
Tecnologia Digitale

Coloured-body fine porcelain stoneware
Digital Technology

Feinsteinzeug aus farbiger Masse
Digital Technologie

Grès cérame fin à pâte colorée
Technologie Numérique

Silk



60×119,5 - 24"×47 1/2"
02995 | Unique Silk Nat/Ret
02999 | Unique Silk Lev/Ret
03003 | Unique Silk Bocciardato Ret U4 P3 E3 C2



80×80 - 31 1/2"×31 1/2"
03639 | Unique Silk Nat/Ret
03641 | Unique Silk Lev/Ret U4 P3 E3 C2



60×60 - 24"×24"
01702 | Unique Silk Nat/Ret
01691 | Unique Silk Lev/Ret U4 P4 E3 C2



60×119,5 - 24"×47 1/2"
03008 | Unique Silk Level Ret



30×60 - 12"×24"
01707 | Unique Silk Nat/Ret
01696 | Unique Silk Lev/Ret U4 P3 E3 C2

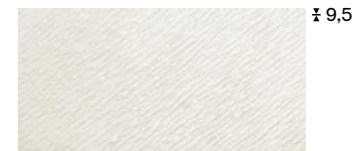

30×60 - 12"×24"
01765 | Unique Silk Iced Lev/Ret

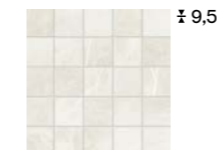

30×30 - 12"×12"
01771 | Unique Silk Mosaico Nat/Ret



10×53 - 4"×20"
01792 | Unique Silk Chevron Nat/Ret U4 P3 E3 C2

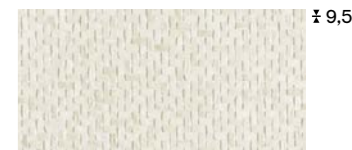

30×60 - 12"×24"
01918 | Unique Weave Sk/Sd Nat/Ret



30×30 - 12"×12"
01786 | Unique Silk Mix All In Ret



30×60 - 12"×24"
01785 | Unique Nite Maya Design Ret



30×60 - 12"×24"
01781 | Unique Silk Maya Ret



Sand



60×119,5 - 24"×47 1/2"
02996 | Unique Sand Nat/Ret U4 P3 E3 C2
03000 | Unique Sand Lev/Ret
03004 | Unique Sand Bocciardato Ret



80×80 - 31 1/2"×31 1/2"
03684 | Unique Sand Nat/Ret U4 P3 E3 C2
03867 | Unique Sand Lev/Ret



60×60 - 24"×24"
01703 | Unique Sand Nat/Ret U4 P4 E3 C2
01692 | Unique Sand Lev/Ret



60×119,5 - 24"×47 1/2"
03009 | Unique Sand Level Ret



30×60 - 12"×24"
01708 | Unique Sand Nat/Ret U4 P3 E3 C2
01697 | Unique Sand Lev/Ret

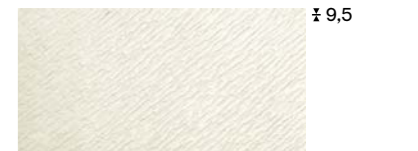

30×60 - 12"×24"
01766 | Unique Sand Iced Lev/Ret



30×30 - 12"×12"
01772 | Unique Sand Mosaico Nat/Ret



10×53 - 4"×20"
01793 | Unique Sand Chevron Nat/Ret U4 P3 E3 C2



30×60 - 12"×24"
01918 | Unique Weave Sk/Sd Nat/Ret



30×30 - 12"×12"
01787 | Unique Sand Mix All In Ret



30×60 - 12"×24"
01782 | Unique Sand Maya Ret

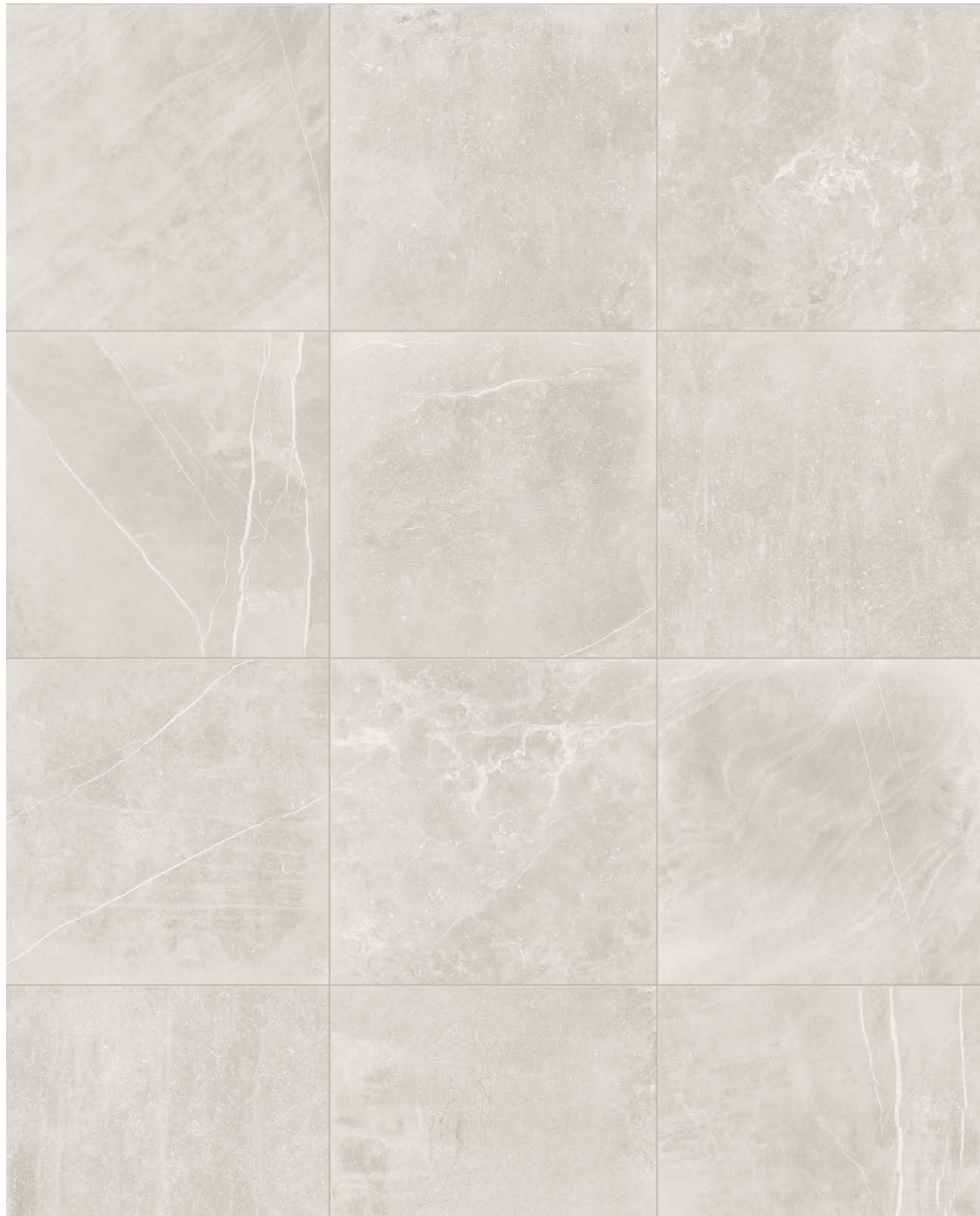

Gres fine porcellanato ad impasto colorato
Tecnologia Digitale

Coloured-body fine porcelain stoneware
Digital Technology

Feinsteinzeug aus farbiger Masse
Digital Technologie

Grès cérame fin à pâte colorée
Technologie Numérique

Silver



± 9,5

60×119,5 - 24"×47½"

02997 | Unique Silver Nat/Ret
03001 | Unique Silver Lev/Ret
03005 | Unique Silver Bocciardato Ret

U4 P3 E3 C2



± 9,5

80×80 - 31½"×31½"

03642 | Unique Silver Nat/Ret
03643 | Unique Silver Lev/Ret

U4 P3 E3 C2



± 9,5

60×60 - 24"×24"

01704 | Unique Silver Nat/Ret
01693 | Unique Silver Lev/Ret

U4 P4 E3 C2



± 9,5

60×119,5 - 24"×47½"

03010 | Unique Silver Level Ret



± 9,5

30×60 - 12"×24"

01709 | Unique Silver Nat/Ret
01698 | Unique Silver Lev/Ret

U4 P3 E3 C2

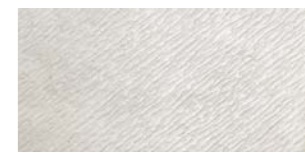

± 9,5

30×60 - 12"×24"

01767 | Unique Silver Iced Lev/Ret

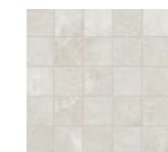

± 9,5

30×30 - 12"×12"

01773 | Unique Silver Mosaico Nat/Ret



± 9,5

10×53 - 4"×20"

01794 | Unique Silver Chevron Nat/Ret

U4 P3 E3 C2

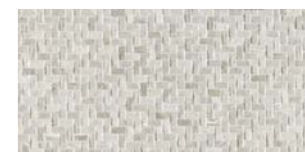

± 9,5

30×60 - 12"×24"

01917 | Unique Weave Tm/Sr Nat/Ret



± 9,5

30×30 - 12"×12"

01788 | Unique Silver Mix All In Ret



± 9,5

30×60 - 12"×24"

01785 | Unique Nite Maya Design Ret

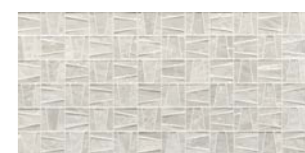

± 9,5

30×60 - 12"×24"

01783 | Unique Silver Maya Ret

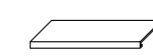
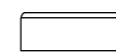



Titanium



± 9,5

60×119,5 - 24"×47½"

02976 | Unique Titanium Nat/Ret
02977 | Unique Titanium Lev/Ret
03006 | Unique Titanium Bocciardato Ret

U4 P3 E3 C2



± 9,5

80×80 - 31½"×31½"

03637 | Unique Titanium Nat/Ret
03638 | Unique Titanium Lev/Ret

U4 P3 E3 C2



± 9,5

60×60 - 24"×24"

01705 | Unique Titanium Nat/Ret
01694 | Unique Titanium Lev/Ret

U4 P4 E3 C2



± 9,5

60×119,5 - 24"×47½"

03011 | Unique Titanium Level Ret



± 9,5

30×60 - 12"×24"

01711 | Unique Titanium Nat/Ret
01699 | Unique Titanium Lev/Ret

U4 P3 E3 C2



± 9,5

30×60 - 12"×24"

01768 | Unique Titanium Iced Lev/Ret



± 9,5

30×30 - 12"×12"

01774 | Unique Titanium Mosaico Nat/Ret



± 9,5

10×53 - 4"×20"

01795 | Unique Titanium Chevron Nat/Ret

U4 P3 E3 C2

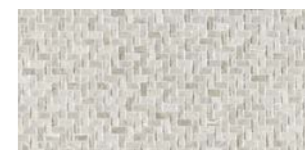

± 9,5

30×60 - 12"×24"

01917 | Unique Weave Tm/Sr Nat/Ret



± 9,5

30×30 - 12"×12"

01789 | Unique Titanium Mix All In Ret



± 9,5

30×60 - 12"×24"

01785 | Unique Nite Maya Design Ret



± 9,5

30×60 - 12"×24"

01784 | Unique Titanium Maya Ret

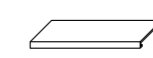
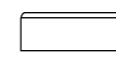



Nite



60x119,5 - 24"x47 1/2"
02998 | Unique Nite Nat/Ret U4 P3 E3 C2
03002 | Unique Nite Lev/Ret
03007 | Unique Nite Bocciardato Ret

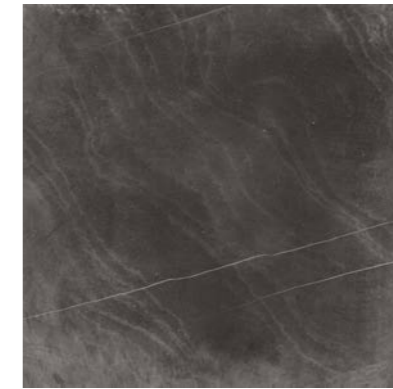

80x80 - 31 1/2"x31 1/2"
03617 | Unique Nite Nat/Ret U4 P3 E3 C2
03618 | Unique Nite Lev/Ret



60x60 - 24"x24"
01706 | Unique Nite Nat/Ret U4 P4 E3 C2
01695 | Unique Nite Lev/Ret



60x119,5 - 24"x47 1/2"
03012 | Unique Nite Level Ret



30x60 - 12"x24"
01712 | Unique Nite Nat/Ret U4 P3 E3 C2
01701 | Unique Nite Lev/Ret

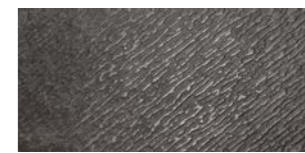

30x60 - 12"x24"
01769 | Unique Nite Iced Lev/Ret

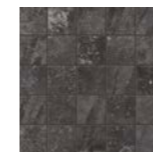

30x30 - 12"x12"
01775 | Unique Nite Mosaico Nat/Ret



10x53 - 4"x20"
01796 | Unique Nite Chevron Nat/Ret U4 P3 E3 C2



30x30 - 12"x12"
01791 | Unique Nite Mix All In Ret



30x60 - 12"x24"
01785 | Unique Nite Maya Design Ret

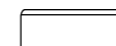

Riepilogo Gamma

Collection
Serie
Gamme

Formati Sizes									Strutture 3D 3D Structures				
	60x119,5 24"x47½"	80x80* 31½"x31½"	60x60 24"x24"	30x60 12"x24"	Chevron 10x53 - 4"x20"	DIN 51130	DIN 51097	DCOF	Level 60x119,5 24"x47½"	Maya 30x60 12"x24"	Iced 30x60 12"x24"	Weave 30x60 12"x24"	
	± 9,5	± 9,5	± 9,5	± 9,5	± 9,5				± 9,5	± 9,5	± 9,5	± 9,5	
 Silk	Nat/Ret	02995	03639	01702	01707	01792	R10	A+B	>0.42	03008	01781		01918
	Lev/Ret	02999	03641	01691	01696		V3				01765		
	Bocciardato	03003					R11	A+B+C	>0.42				
 Sand	Nat/Ret	02996	03684	01703	01708	01793	R10	A+B	>0.42	03009	01782		01918
	Lev/Ret	03000	03867	01692	01697		V3				01766		
	Bocciardato	03004					R11	A+B+C	>0.42				
 Silver	Nat/Ret	02997	03642	01704	01709	01794	R10	A+B	>0.42	03010	01783		01917
	Lev/Ret	03301	03643	01693	01698		V3				01767		
	Bocciardato	03005					R11	A+B+C	>0.42				
 Titanium	Nat/Ret	02976	03637	01705	01711	01795	R10	A+B	>0.42	03011	01784		01917
	Lev/Ret	02977	03638	01694	01699		V3				01768		
	Bocciardato	03006					R11	A+B+C	>0.42				
 Nite	Nat/Ret	02998	03617	01706	01712	01796	R10	A+B	>0.42	03012	01785		
	Lev/Ret	03002	03618	01695	01701		V3				01769		
	Bocciardato	03307					R11	A+B+C	>0.42				







*Attenzione: verificare in fase di ordine il codice e l'imballo (80x80)
 *Note: In the ordering phase please check code and packaging (80x80)
 *Bitteachten: Beim Bestellen bitte die Kodenummer und die Verpackung kontrollieren (80x80)
 *Attention : Merci de vérifier emballage et la référence au moment de la commande (80x80)

Riepilogo Gamma

Collection
Serie
Gamme

Formati Sizes			Pezzi Speciali Special Pieces				
	Mosaico 30x30 - 12"x12"	Mosaico Mix All In 30x30 - 12"x12"	Gradino Costa Retta 33x119,5 - 13"x47½"	Battiscopa 6,5x120 - 2½"x48"	Battiscopa 8x80 - 3¼"x31½"	Battiscopa 8x60 - 3¼"x24"	
	± 9,5	± 9,5	± 9,5	± 10,5	± 10,5	± 9,5	
 Silk	Nat/Ret	01771		03733	01797	01808	01819
	Lev/Ret		01786		01803	01814	01825
 Sand	Nat/Ret	01772		03734	01798	01809	01821
	Lev/Ret		01787		01804	01815	01826
 Silver	Nat/Ret	01773		03735	01799	01811	01822
	Lev/Ret		01788		01805	01816	01827
 Titanium	Nat/Ret	01774		03736	01801	01812	01823
	Lev/Ret		01789		01806	01817	01828
 Nite	Nat/Ret	01775		03737	01802	01813	01824
	Lev/Ret		01791		01807	01818	01829

Packing
Verpackung
Emballage

Formati Sizes		± MM	 Pezzi Scatola Pieces/Box Stck/Karton Carreaux/Boîte	 Mq/Scatola Sqmt/Box Qm/Karton M2/Boîte	 Kg/Scatola Kgs/Box Kg/Karton Kg/Boîte	 Scatole/Paletta Boxes/Pallet Karton/Palette Boîte/Palette	 Mq/Paletta Sqmt/Pallet Qm/Pallet M2/Palette	 Kg/Paletta Kgs/Pallet Kg/Pallet Kg/Palette	 Formato Paletta Size Pallet Format Pallet Dim. Palette
60×119,5 (24"×47½") Nat/Ret	P	9,5	2	1,434	31,00	30	43,02	930	120×80×75
60×119,5 (24"×47½") Lev/Ret	P	9,5	2	1,434	32,00	30	43,02	960	120×80×75
60×119,5 (24"×47½") Bocciardato Ret - Level Ret	P	9,5	2	1,434	31,00	30	43,02	930	120×80×75
*80×80 (31½"×31½") Nat/Ret - Lev/Ret	P	9,5	2	1,280	27,50	50	64	1375	120×80×96
60×60 (24"×24") Nat/Ret	P	9,5	3	1,080	21,50	40	43,20	860	120×80×75
60×60 (24"×24") Lev/Ret	P	9,5	3	1,080	22,50	40	43,20	900	120×80×75
30×60 (12"×24") Nat/Ret	P	9,5	6	1,080	21,50	48	51,84	1032	120×80×75
30×60 (12"×24") Lev/Ret	P	9,5	6	1,080	22,50	48	51,84	1080	120×80×75
30×60 (12"×24") Maya Ret	P	9,5	6	1,080	21,50	40	43,20	860	120×80×75
30×60 (12"×24") Iced Lev/Ret	P	9,5	6	1,080	21,50	40	43,20	860	120×80×75
30×60 (12"×24") Weave Nat/Ret	P	9,5	6	1,080	21,50	40	43,20	860	120×80×75
10×53 (4"×20") Chevron Nat/Ret	P	9,5	12	0,636	13,20	60	38,16	792	120×80×75
30×30 (12"×12") Mosaico Nat/Ret	P	9,5	5	0,450	8,50	60	-	-	-
30×30 (12"×12") Mosaico All In Ret	P	9,5	6	0,540	10,20	54	-	-	-
Pezzi Speciali / Special Pieces									
33×119,5 (13"×47½") Gradino Costa Retta Nat/Ret	P	9,5	2	0,789	18,50	20	-	-	-
8×60 (3¼"×24") Battiscopa Nat/Ret	P	9,5	10	0,480	11,00	72	-	-	-
8×60 (3¼"×24") Battiscopa Lev/Ret	P	9,5	10	0,480	11,00	72	-	-	-
8×80 (3¼"×31½") Battiscopa Nat/Ret	P	10,5	7	0,450	11,00	65	-	-	-
8×80 (3¼"×31½") Battiscopa Lev/Ret	P	10,5	7	0,450	11,00	65	-	-	-
6,5×120 (2½"×48") Battiscopa Nat/Ret - Lev/Ret	P	10,5	8	0,624	14,00	48	-	-	-

Special pieces
Formstücke
Pièces spéciales

Battiscopa Nat/Ret 8×60 – 3¼"×24" ± 9,5
Battiscopa Lev/Ret 8×60 – 3¼"×24" ± 9,5

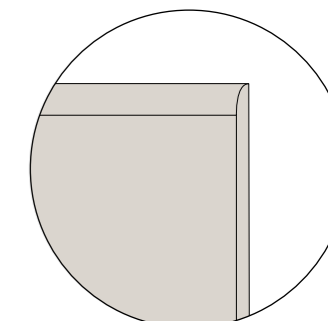
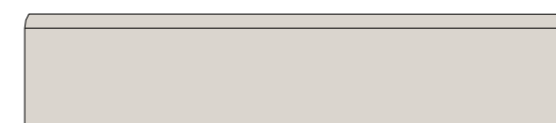

Battiscopa Nat/Ret 8×80 – 3¼"×31½" ± 10,5
Battiscopa Lev/Ret 8×80 – 3¼"×31½" ± 10,5

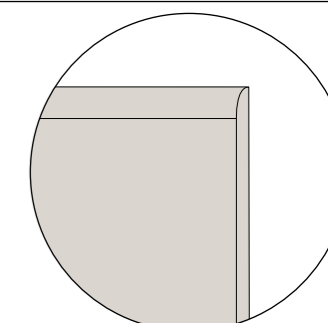
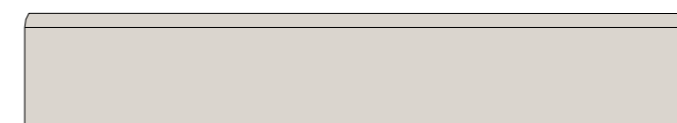

Battiscopa Nat/Ret 6,5×120 – 2½"×48" ± 10,5
Battiscopa Lev/Ret 6,5×120 – 2½"×48" ± 10,5

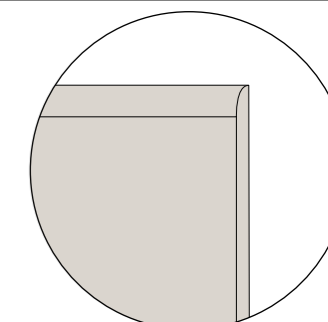

Gradino Costa Retta Nat/Ret 33×119,5 – 13"×47½" ± 9,5
(costa retta ottenuto per taglio e incollaggio - obtained by cutting and gluing)

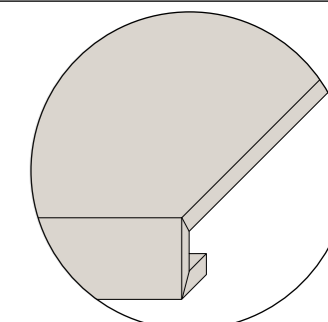

*Attenzione: verificare in fase di ordine il codice e l'imballo (80×80)
*Note: In the ordering phase please check code and packaging (80×80)
*Bitteachten: Beim Bestellen bitte die Kodenummer und die Verpackung kontrollieren (80×80)
*Attention : Merci de vérifier emballage et la référence au moment de la commande (80×80)

Caratteristiche Tecniche

Technical characteristics

Technische daten

Caracteristiques techniques

CLASSIFICAZIONE SECONDO NORME EN 14411 B_A – ISO 13006 - CLASSIFICATION IN ACCORDANCE WITH EN 14411 B_A – ISO 13006
KLASSIFIZIERUNG GEMÄSS NORMEN EN 14411 B_A – ISO 13006 - CLASSIFICATION SELON LES NORMES EN 14411 B_A – ISO 13006

CARATTERISTICA TECNICA TECHNICAL CHARACTERISTIC TECHNISCHE DATE CARACTÉRISTIQUE TECHNIQUE	NORMA NORM NORME	VALORE PRESCRITTO VALUE REQUIRED NORMVORGABE VALEUR PRESCRIPTE	VALORE MEDIO MEAN VALUE MITTELWERT VALEUR MOYENNE	USA TESTS	VALORE MEDIO MEAN VALUE MITTELWERT VALEUR MOYENNE
LUNGHEZZA E LARGHEZZA LENGHT AND WIDTH / LÄNGE UND BREITE / LONGUEUR ET LARGEUR		±0.6% (±2,00 MM)			
SPESORE THICKNESS / STÄRKE / EPAISSEUR		±5% (±0,5 MM)			
RETTILINEITÀ LATI WARPAGES OF EDGES / GERADHEIT DER KANTEN / RECTITUDE DES ARÊTES	ISO 10545.2	±0.5% (±15 MM)	CONFORME IN ACCORDANCE ERFÜLLT CONFORME	ASTM C-499 ASTM C-485 ASTM C-502	IN ACCORDANCE
ORTOGONALITÀ WEDGING / RECHTWINKLIGKEIT / ORTHOGONALITÉ		±0,5% (±2,00 MM)			
PLANARITÀ FLATNESS / PLANITÄT / PLANIMÉTRIE		±0,5% (±2,00 MM)			
ASSORBIMENTO % D'ACQUA WATER ABSORPTION WASSERANFÄHME % ABSORPTION D'EAU %	ISO 10545.3	≤ 0,5%	CONFORME IN ACCORDANCE ERFÜLLT CONFORME	ASTM C-373	IN ACCORDANCE
RESISTENZA ALLA FLESSIONE BENDING STRENGTH BIEGEZUGFESTIGKEIT RÉSISTANCE À LA FLEXION	ISO 10545.4	Modulus of rupture (average): R ≥ 35N/mm ² Breaking strength for thickness ≥ 7,5 mm S > 1500 N	CONFORME IN ACCORDANCE ERFÜLLT CONFORME	ASTM C-648 250 LBS OR GREATER	IN ACCORDANCE
DILATAZIONE TERMICA LINEARE TRA 20° E 100° C LINEAR THERMAL EXPANSION BETWEEN 20° AND 100° C LINEARE WÄRMEAUSENDENUNG ZWISCHEN 20° UND 100° C DILATATION THERMIQUE LINEAIRE ENTRE 20° ET 100° C	ISO 10545.8	SECONDO I DATI DEL COSTRUTTORE ACCORDING TO BUILDER'S SPECIFICATIONS LAUT ANGABEN DES HERSTELLERS SELON LES ELEMENTS DU CONSTRUCTEUR	≈ 7x10 ⁻⁶ C ⁻¹		
RESISTENZA AGLI SBALZI TERMICI THERMAL SHOCK RESISTANCE TEMPERATURWECHSELBESTÄNDIGKEIT RÉSISTANCE AUX ÉCARTS DE TEMPÉRATURE	ISO 10545.9	RICHIESTA REQUEST BITTE DEMANDE	RESISTENTE RESISTANT WIDERSTEHEND RÉSISTANT		
RESISTENZA AL GELO FROST RESISTANCE FROSTBESTÄNDIGKEIT RÉSISTANCE AU GEL	ISO 10545.12	RICHIESTA REQUEST BITTE DEMANDE	RESISTENTE RESISTANT WIDERSTEHEND RÉSISTANT	ASTM C-1026	IN ACCORDANCE
RESISTENZA ALL'ATTACCO CHIMICO RESISTANCE TO CHEMICAL ATTACK BESTÄNDIGKEIT GEGEN CHEMIKALIEN RÉSISTANCE À L'ATTAQUE CHIMIQUE	ISO 10545.13	SECONDO I DATI DEL COSTRUTTORE ACCORDING TO BUILDER'S SPECIFICATIONS LAUT ANGABEN DES HERSTELLERS SELON LES ELEMENTS DU CONSTRUCTEUR	RESISTENTE RESISTANT WIDERSTEHEND RÉSISTANT	ASTM C-650	IN ACCORDANCE
RESISTENZA DEI COLORI ALLA LUCE COLOURS RESISTANCE TO LIGHT LICHTBESTÄNDIGKEIT RÉSISTANCE DES COULEURS À LA LUMIÈRE	DIN 51094	NESSUNA ALTERAZIONE NO ALTERATION KEINE VERÄNDERUNG AUCUNE ALTERATION	CONFORME IN ACCORDANCE ERFÜLLT CONFORME		
RESISTENZA ALLE MACCHIE STAIN RESISTANCE FLECKENFESTIGKEIT RÉSISTANCE AUX TACHES	ISO 10545.14	≥ CLASSE 3 METODO DI PROVA DISPONIBILE TEST METHOD AVAILABLE VERFÜGBARE PRÜFMETHODE METHODE D'ESSAI DISPONIBILE	CONFORME IN ACCORDANCE ERFÜLLT CONFORME		
RESISTENZA ALLO SCIVOLAMENTO SLIPPAGE RESISTANCE RUTSCHSICHERHEIT RÉSISTANCE AU GLISSEMENT	DIN 51130 *	9 s R s13	NATURALE R10 LEVIGATO R11 ANTISLIP	ASTM C-1028 * COF ≥ 0,6 DRY ≥ 0,6 WET	NATURALE LEVIGATO ANTISLIP
	DIN 51097 *	A,B,C	NATURALE A+B LEVIGATO A+B+C ANTISLIP	ANSI * 137.1-2012 DCOF > 0,42 WET	NATURALE > 0,42 LEVIGATO ANTISLIP > 0,42
	BS EN 7976-2*	> 36 DRY > 36 WET	NATURALE LEVIGATO ANTISLIP	AS 4586: 2013 CLASS	NATURALE LEVIGATO ANTISLIP

* TRATTANDOSI DI NORMATIVE NAZIONALI, I METODI DI PROVA, I REQUISITI E LE CLASSIFICAZIONI VARIANO DA PAESE A PAESE. IL VALORE ATTESO DALLA RESISTENZA ALLO SCIVOLAMENTO DELLA PRODUZIONE DI INDUSTRIE CERAMICHE PIEMME S.P.A., PUÒ VARIARE IN BASE AL LOTTO PRODUTTIVO. SPECIFICA DOCUMENTAZIONE È DISPONIBILE SU RICHIESTA. ELENCO DELLE SERIE CERTIFICATE E CLASSIFICAZIONI DISPONIBILI A RICHIESTA.
TEST METHODS, REQUIREMENTS AND CLASSIFICATIONS DIFFER FROM COUNTRY TO COUNTRY, ACCORDING TO THE NATIONAL REGULATIONS. THE EXPECTED VALUE OF SLIPPAGE RESISTANCE OF PRODUCTS BY INDUSTRIE CERAMICHE PIEMME S.P.A. MAY VARY DEPENDING ON THE PRODUCTION BATCH. SPECIFIC DOCUMENTS ARE AVAILABLE UPON REQUEST. LIST OF CERTIFIED SERIES AND CLASSIFICATIONS AVAILABLE UPON REQUEST.
PRÜFVERFAHREN, ERFORDERNISSE UND KLASSIFIKATIONEN SIND VERSCHIEDEN VON LAND ZU LAND, GEMÄSS DER NATIONALEN VORSCHRIFTEN. DER ERWARTUNGSWERT DER RUTSCHSICHERHEIT DER PRODUKTE VON INDUSTRIE CERAMICHE PIEMME S.P.A. KANN SICH - JE NACH DER PRODUKTIONSPARTIE - VERÄNDERN. SPEZIFISCHE UNTERLAGEN SIND AUF VERLANGEN ZUR VERFÜGUNG. LISTE DER GEPRÜFTEN SERIE UND KLASSIFIZIERUNGEN AUF ANFRAGE ERHÄLTICH.
LES MÉTHODES D'ESSAI, LES RÉQUISITIONS ET LES CLASSIFICATIONS CHANGENT DE PAYS À PAYS, SELON LES RÉGLEMENTATIONS NATIONALES. LA VALEUR ATTENDUE DE RÉSISTANCE AU GLISSEMENT DES PRODUITS DE INDUSTRIE CERAMICHE PIEMME S.P.A. PEUT VARIER EN FONCTION DU LOT DE PRODUCTION. UNE DOCUMENTATION SPÉCIFIQUE EST DISPONIBLE SUR DEMANDE. LISTE DES SERIES CERTIFIÉES ET DES CLASSEMENTS DISPONIBLES SUR DEMANDE.
CONCERNANT LA NORME UPEC, VEUILLEZ SVP VÉRIFIER DIRECTEMENT SUR INTERNET EN TAPANT "UPEC PIEMME" LES RÉFÉRENCES ET/OU FINITIONS ÉVENTUELLEMENT PAS ENCORE À CE JOUR CERTIFIÉES.



CERAMICHE PIEMME
FLOOR AND MORE



Norme per la posa e la manutenzione

Installation and maintenance instructions

Verlegung, reiningung und pflege

Guide a la pose et l'entretien

<ul style="list-style-type: none">Per i prodotti rettificati consigliamo una fuga di 2 mm per un migliore risultato di posa.Per una migliore resa estetica Piemme consiglia stuccature colorate in tinta con le piastrelle. Verificare, prima dell'utilizzo, la compatibilità ed idoneità dei riempitivi per fughe con il prodotto ceramico.Rimuovere le eccedenze dei riempitivi per fughe quando gli stessi sono ancora freschi.Attenersi scrupolosamente alle istruzioni indicate dai produttori dei riempitivi per fughe.	<ul style="list-style-type: none">Per eliminare completamente i residui di posa, che potrebbero compromettere la manutenzione ordinaria e le caratteristiche del prodotto, a posa ultimata, procedere con la pulizia utilizzando prodotti adeguati, a base Acida max 3%, rispettando le indicazioni del produttore. Osservare assolutamente i limiti di tempo indicati nelle istruzioni: un contatto troppo prolungato con questi prodotti potrebbe provocare il danneggiamento della superficie.Gli eventuali aloni che si dovessero presentare dopo la posa di materiali lappati o levigati si potranno facilmente eliminare utilizzando un prodotto idoneo, a base Alcalina.	<ul style="list-style-type: none">Riguardo l'utilizzo di materiali ceramici all'esterno, pure riconfermando l'ingelività dei prodotti Piemme in gres porcellanato, in conformità alle vigenti normative europee EN 14411/ISO 13006-ISO 10545.12, occorre attenersi ad alcune fondamentali norme previste per la posa all'esterno, atte a rendere inattaccabili al gelo i predetti pavimenti. Le condizioni più importanti da rispettare sono: le opportune pendenze, le impermeabilizzazioni, i giunti di dilatazione, e l'uso di idonei materiali per la posa.Decorazioni realizzate con smalti e metalli preziosi sono indispensabili proteggere la superficie durante la posa, non utilizzare assolutamente prodotti abrasivi e/o acidi, ma solo acqua e sapone neutro. Il produttore non risponde di eventuali danni a questi preziosi materiali causati da "sfregamenti" durante la posa in opera. Per nessun motivo saranno accettate contestazioni relative a materiale posato.	TIPO DI SPORCO	INDICAZIONI PER LA PULIZIA
			Birra, Caffè, Gelato, Vino Gomma Pneumatico, Grassi vegetali e animali, Inchiostri, Lampostili Olii Meccanici, Residui di scotch Ollo di lino, PennarelloResine Smalti, Tintura per capelli	Prodotti a Base Alcalina
			Cera protettiva anti-abrasione, Depositi calcarei, Macchie di ruggine	Prodotti a Base Acida
			Cera di candela, Residui di scotch	Solventi
Per ulteriori informazioni specifiche consultare l'area tecnica sul sito Piemme: www.ceramichepiemme.it				
			TYPE OF STAIN	CLEANING SUGGESTIONS
			beer, coffee, wine, ice cream vegetable and animal fats, rubber, remains of scotch tape, grease from machines, linseed oil, felt tip pens, paints, inks, hair dye	Alkaline-based detergent
			protective anti-abrasion wax, calcareous residuals, rust stains	Acid-based detergent
			candle wax, remains of scotch-tape	Solvents
For further specific details please visit the technical area on Piemme website: www.ceramichepiemme.it				
			VERSCHMUTZUNGSART	REINIGUNGSHINWEISE
			Bier, Wein, Eis, Kaffee Tierische oder pflanzliche Fette Gummi, Kleberbandresten Schmieröl, Tinte, Leilöl, Filzstift, Harz oder Lack, Haarfarbe	Alkalische Reinigungsmittel
			Kratzschutz-Wachs, Kalkablagerung, Rostflecken	Säure-Reinigungsmittel
			Kerzenwachs Kleberbandresten	Lösungsmittel
Weitere Einzelheiten finden Sie in dem technischen Bereich des Piemme website: www.ceramichepiemme.it				
			TYPE DE TACHE	NETTOYAGE CONSEIL
			Bière, Vin, Glace, Café, Graisses végétales et animales, Encres, Résidus de scotch, Huile de graissage, Hile de lin Crayon feutre Emaux, Teinture pour cheveux, Caoutchouc pour pneus	Détergents à base alcaline
			Cire de protection anti abrasion, Dépôts de calcaire, Tache de rouille	Détergents à base d'acide
			Cire de bougie Résidus de scotch	Solvant
Pour d'ultérieures Information spécifiques consulter le département technique du site Piemme: www.ceramichepiemme.it				

Reading Guide
Leseanleitung
Guide à la lecture

▼ Spessore
Thickness
Stärke
Épaisseur

Variazione nelle sfumature di colore
Color shade variations
Variation der Farbnuancen
Variation des nuances de couleur

Resistenza alla scivolosità
Skid resistance
Rutschfestigkeit
Resistance au glissement

V1 Aspetto uniforme
Uniform appearance
Gleichförmiges aussehen
Aspect uniforme

V2 Variazione leggera
Slight variation
Leichte variation
Variation légère

V3 Variazione moderata
Moderate variation
Mäßige variation
Variation modeste

V4 Variazione casuale
Random variation
Zufällige variation
Variation fortuite

DIN 51130	DIN 51097	DCOF
R10	A	>0,42

Tutti i formati sono nominali.

All sizes are nominal.

Die Formate sind Nennwerte.

Tous les formats sont nominaux.

Gli spessori riportati in questo catalogo sono nominali e possono variare a seconda dei formati e delle finiture.

The thickness mentioned on this catalogue are nominal and can be different according to the sizes and the finishes.

Die in diesem Katalog angegebenen Fliesenstärke sind nominal und können, je nach Format oder Oberfläche, verschieden sein.

Les épaisseurs reportées sur ce catalogue sont nominales et peuvent varier suivant les formats et les finitions.

I colori e le caratteristiche estetiche dei prodotti sono quanto più possibile vicini a quelli reali, nei limiti consentiti dai processi di stampa.

The colours and appearance features of the products are as close as possible to reality, within the limitation of the printing process.

Die Farben und die ästhetischen Eigenschaften der Produkte entsprechen der Wirklichkeit, innerhalb den von dem Druckverfahren erlaubten Grenzen.

Les couleurs et les caractéristiques esthétiques sont fidèles aux couleurs et caractéristiques réelles dans les limites des procédés d'impression.



Ceramics of Italy rappresenta la volontà dell'industria italiana delle piastrelle di ceramica nel diffondere e promuovere una nuova valenza della piastrella di ceramica: non più solo un prodotto per l'industria delle costruzioni, ma punto di riferimento per stile e creatività per lo sviluppo di una nuova cultura dell'abitare Made in Italy.

Ceramics of Italy represents the willingness of the Italian ceramic tile industry to spread and promote a new concept of ceramic tile: no longer just a product for the construction industry, but a focal point for style and creativity in the development of a new culture of living Made in Italy.

Project Management
Mktg Piemme

Gennaio 2021
January 2021

Una storia tutta italiana

Piemme dal 1962, anno della sua fondazione, è protagonista indiscussa del vero Made in Italy, quello fatto di eccellenza, passione e creatività. Oggi tutti i materiali Piemme sono prodotti con tecnologia d'avanguardia come la decorazione digitale inkjet HD, la cottura in forni ad energia pulita a recupero di calore, la rettifica e levigatura in linea "one roof" e la verifica elettronica dello standard qualitativo.

An all-Italian story

Since 1962, the year of its foundation, Piemme has been the undisputed protagonist of real Made in Italy, that which consists of excellence, passion and creativity. Today, all Piemme materials are made using cuttingedge technology such as HD inkjet digital decoration, firing in heat-recycling cleanenergy kilns, "one roof" grinding and polishing line and electronic quality standard control.

Eine ganz italienische Geschichte

Seit dem Gründungsjahr 1962 ist Piemme ein unangefochtener Hauptakteur des echten Made in Italy: jenem, das auf Exzellenz, Leidenschaft und Kreativität gründet. Alle Piemme Erzeugnisse werden heute unter Einsatz von Spitzentechnologie produziert, wie zum Beispiel mit der digitalen Inkjet-Dekoration, dem Brennen in Öfen mit grüner Energie und Wärmerückgewinnung, dem Schleifen und Polieren in der Linie „unter einem Dach“ sowie der elektronischen Prüfung des Qualitätsniveaus.

Une histoire toute italienne

Depuis 1962, l'année de sa fondation, Piemme est la protagoniste indiscutée du Made in Italy, basé sur l'excellence, la passion et la créativité. Aujourd'hui toutes les phases du cycle de fabrication Piemme sont issues d'une technologie à l'avant-garde comme la décoration numérique inkjet HD, la cuisson dans des fours à énergie propre et à récupération de chaleur, la rectification et le polissage en en ligne "one roof" et la vérification électronique de la qualité.

CERAMICHE PIEMME

FLOOR AND MORE

INDUSTRIE CERAMICHE PIEMME S.P.A.
VIA DEL CROCIALE 42/44, 41042 FIORANO (MO) - ITALY
T. +39 0536.849111 - F. +39 0536.849402
WWW.CERAMICHEPIEMME.IT - INFO@CERAMICHEPIEMME.IT

CERAMICHE PIEMME
FLOOR AND MORE

UNIQUESTONE



L'equilibrio attraverso la varietà.

STABILITY THROUGH VARIETY.

TUTTO CAMBIA E SI TRASFORMA.
NOI LO SAPPIAMO BENE E ABBIAMO DECISO DI ACCETTARE LA SFIDA
DINAMICA DEL CAMBIAMENTO INDOSSANDO UN NUOVO ABITO.
ABBIAMO DECISO DI GUARDARCI ALLO SPECCHIO PERCHÉ I TEMPI
ERANO MATURI PER COMPIERE UN BILANCIO E COSÌ, DOPO AVER
SCOPERTO E RISCOPERTO TANTO DI NOI.
ABBIAMO VOLUTO COMUNICARE ANCHE ALL'ESTERNO NUOVE E
RINNOVATE CONSAPEVOLEZZE.
CON IL PROCESSO DI REBRANDING CHE ABBIAMO MESSO IN ATTO.
CERAMICHE PIEMME - FLOOR AND MORE, RAPPRESENTA:
TECNOLOGIA, ESSENZIALITÀ, QUALITÀ E CAPACITÀ DI ADATTARSI
TRASVERSALMENTE ALLE SCELTE DI STILE, MA SOPRATTUTTO DI
VITA, DEI NOSTRI CLIENTI.

CERAMI- CHE PIEMME

EVERYTHING CHANGES AND EVOLVES. WE ARE WELL AWARE OF THIS, AND WE DECIDED TO TAKE UP THE DYNAMIC CHALLENGE OF CHANGE BY PUTTING ON A NEW OUTFIT. WE DECIDED TO TAKE A CLOSE LOOK AT OURSELVES BECAUSE THE TIME WAS RIPE TO TAKE STOCK, THEN AFTER WE FOUND OUT - AND REDISCOVERED - A LOT ABOUT OURSELVES, WE DECIDED TO SHARE OUR NEW, REVAMPED KNOWLEDGE WITH THE OUTSIDE WORLD AS WELL. WITH THE PROCESS OF REBRANDING THAT WE HAVE IMPLEMENTED, CERAMICHE PIEMME - FLOOR AND MORE, WILL REPRESENT: TECHNOLOGY, ESSENTIALS, QUALITY AND THE CAPACITY FOR ALL-EMBRACING ADAPTATION TO OUR CLIENTS' STYLE CHOICES, AND EVEN MORE IMPORTANTLY, THEIR LIFESTYLE CHOICES.

ALLES VERÄNDERT UND VERWANDELT SICH. DAS WISSEN WIR GUT, UND WIR NEHMEN DIE DYNAMISCHE HERAUSFORDERUNG DES WANDELS AN. NEU GEKLEIDET. WIR HABEN UNS IM SPIEGEL BETRACHTET, DENN DIE ZEIT WAR REIF, UM BILANZ ZU ZIEHEN. UND NACHDEM WIR VIEL VON UNS ENTDECKT UND WIEDERENTDECKT HABEN, WOLLTEN WIR UNSER NEUES UND ERNEUERTES BEWUSSTSEIN AUCH NACH AUSSEN KOMMUNIZIEREN. UNSER REBRANDING CERAMICHE PIEMME - FLOOR AND MORE STEHT FÜR: TECHNOLOGIE, MINIMALISMUS, QUALITÄT UND DIE FÄHIGKEIT, SICH DEN STIL- UND VOR ALLEM DEN LEBENSENTSCHIEDUNGEN UNSERER KUNDEN ANZUPASSEN.

TOUT SE METAMORPHOSE ET SE TRANSFORME. NOUS LE SAVONS FORT BIEN, ET C'EST POURQUOI NOUS AVONS RELEVÉ LE GRAND DÉFI DU CHANGEMENT EN RENOUVELANT NOTRE LOOK. NOUS AVONS FIXÉ L'IMAGE QUE NOUS REFLETAIT LE MIROIR, PARCE QU'IL ÉTAIT TEMPS POUR NOUS DE FAIRE LE POINT DE LA SITUATION. NOUS AVONS ALORS DÉCOUVERT ET REDECOUVERT UNE FOULE DE CHOSES SUR NOUS, ET C'EST AINSI QUE NOUS AVONS VOULU COMMUNIQUER AU MONDE EXTERIEUR UNE PRISE DE CONSCIENCE NOUVELLE ET RENOUVELEE. NOUS AVONS MIS EN ŒUVRE UN PROCESSUS DE REBRANDING, CERAMICHE PIEMME - FLOOR AND MORE, QUI REPRESENTERA : TECHNOLOGIE, SOBRIÉTÉ, QUALITÉ ET CAPACITÉ D'ADAPTATION TOTALE AUX CHOIX DE STYLE ET DE VIE DE NOTRE CLIENTÈLE.



UNIQUE- STONE

L'EQUILIBRIO ATTRAVERSO LA VARIETÀ.
STABILITY THROUGH VARIETY.
GLEICHGEWICHT IN DER VIELFALT.
L'EQUILIBRE A TRAVERS LA VARIETE.

UNIQESTONE: UNA COLLEZIONE ISPIRATA ALL'ESTETICA DI PIETRE, GRANITI E MARMI DIFFERENTI SAPIENTEMENTE MISCELATI TRA DI LORO PER MUOVERE CON CARATTERE LO STILE DI OGNI AMBIENTE, RESIDENZIALE O COMMERCIALE. LA SUPERFICIE DELLA MATERIA È CARATTERIZZATA DA UNO STONALIZZO GRAFICO BEN BILANCIATO DA UN TONO DI FONDO MORBIDO ED OMOGENEO PER UN RISULTATO FINALE MOLTO EQUILIBRATO NELLA SUA VARIABILITÀ. DISPONIBILE IN CINQUE VARIANTI CROMATICHE IN FINITURA NATURALE E LEVIGATA È IDEALE PER RIVESTIRE AMBIENTI INTERNI ED ESTERNI AD ALTO IMPATTO EMOZIONALE.

UNIQESTONE: A COLLECTION INSPIRED BY THE AESTHETICS OF DIFFERENT STONES, GRANITES AND MARBLES, SKILFULLY MIXED TOGETHER TO MOVE WITH CHARACTER THE STYLE OF EVERY ENVIRONMENT, WHETHER RESIDENTIAL OR COMMERCIAL. THE MATERIAL SURFACE IS DISTINGUISHED BY WELL-BALANCED GRAPHIC COLOUR AND BY A SOFT AND UNIFORM COLOUR BACKGROUND FOR AN END RESULT WHICH IS VERY STABLE IN ITS VARIABILITY. AVAILABLE IN FIVE DIFFERENT COLOURS IN NATURAL AND POLISHED FINISH, IT IS IDEAL FOR COVERING INTERIOR AND OUTDOOR ENVIRONMENTS WITH HIGH EMOTIONAL IMPACT.

UNIQESTONE: EINE AM AUSSEHEN VERSCHIEDENER UND AUF GELUNGENE WEISE MITEINANDER KOMBINIERTER STEINE, GRANITE UND MARMORARTEN INSPIRIERTE KOLLEKTION. BRINGT STILVOLL BEWEGUNG UND CHARAKTER IN JEDEN GEWERBE- ODER WOHNRAUM. DIE OBERFLÄCHE DES MATERIALS IST DURCH GRAFISCHE NUANCIERUNGEN GEPRÄGT, DIE DURCH EINE WEICHE UND GLEICHMÄSSIGE GRUNDNOTE AUSGEGLICHEN WERDEN. DAS SORGT FÜR EINEN TROTZ DER VARIABILITÄT HARMONISCHEN GESAMTEINDRUCK. IN FÜNF FARBVARIANTEN JEWEILS MIT OBERFLÄCHE NATUR UND POLIERT ERHÄLTICH. IDEAL ZUR VERKLEIDUNG VON INNEN- UND AUSSENBEREICHEN VON HOHER EMOZIONALER WIRKUNG

UNIQESTONE: UNE COLLECTION QUI PUISE SON INSPIRATION A L'ESTHETIQUE DE LA PIERRE. PLUSIEURS TYPES DE GRANITS ET DE MARBRES SAVAMMENT MELANGES APPORTENT UNE NOTE AUTHENTIQUE DE CARACTERE A TOUT ESPACE DE VIE, A USAGE PRIVATIF OU COMMERCIAL. LA SURFACE DE LA MATIERE EST CARACTERISEE PAR UN DENUANCEMENT GRAPHIQUE BIEN EQUILIBRE, SUR UN FOND AU TON DOUX ET HOMOGENE, POUR ABOUTIR A UNE VARIABILITE PARFAITEMENT MAITRISEE. EXISTE EN CINQ VARIANTES CHROMATIQUES, FINITION NATURELLE ET POLIE. REVETEMENT IDEAL POUR L'INTERIEUR ET L'EXTERIEUR A FORT IMPACT EMOZIONNEL

INDICE

CONTENTS

INHALT
INDEX

PUBLIC AREAS



SILK
NEGOZIO / SHOP
GESCHÄFT / BOUTIQUE

11

SILVER
LOUNGE AEROPORTO /
AIRPORT LOUNGE /
FLUGHAFEN-LOUNGE /
AÉROPORT LOUNGE

17

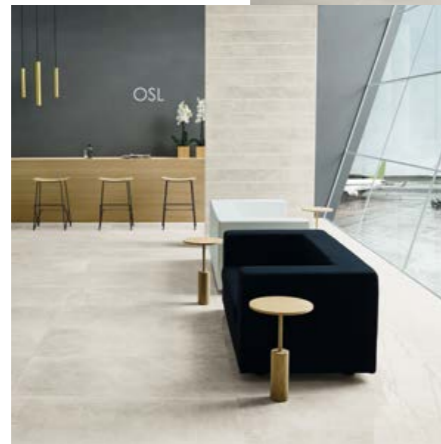

TITANIUM
BOUTIQUE HOTEL / BOUTIQUE HOTEL
HOTELBOUTIQUE / BOUTIQUE D'HOTEL

21

SAND
HALL / HALL
HALLE / HALL

23



NITE
RISTORANTE /
RESTAURANT /
RESTAURANT /
RESTAURANT

25

SAND
CUCINA / KITCHEN
KÜCHE / CUISINE

29



RESIDENTIAL SPACES

SILVER
INGRESSO / ENTRANCE
EINGANG / ENTREE

33



SILK
LIVING / LIVING AREA
SALON / LIVING

35

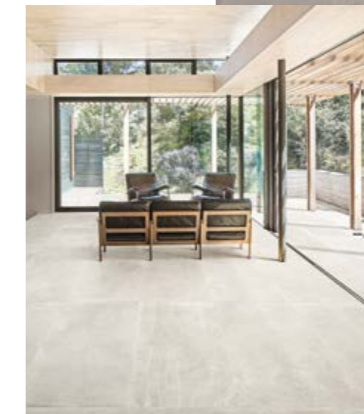

SILVER
LOUNGE AEROPORTO /
AIRPORT LOUNGE /
FLUGHAFEN-LOUNGE /
AÉROPORT LOUNGE

17

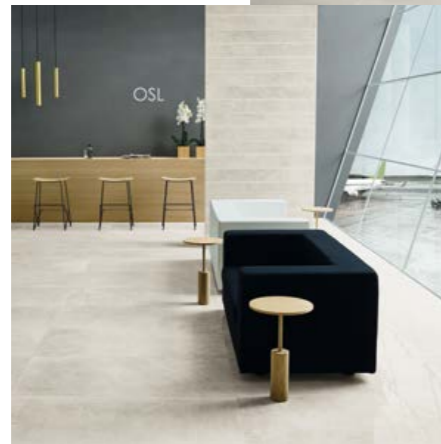

TITANIUM
BOUTIQUE HOTEL / BOUTIQUE HOTEL
HOTELBOUTIQUE / BOUTIQUE D'HOTEL

21

SAND
HALL / HALL
HALLE / HALL

23



NITE
RISTORANTE /
RESTAURANT /
RESTAURANT /
RESTAURANT

25

SAND
CUCINA / KITCHEN
KÜCHE / CUISINE

29



RESIDENTIAL SPACES

SILVER
INGRESSO / ENTRANCE
EINGANG / ENTREE

33



SILK
LIVING / LIVING AREA
SALON / LIVING

35

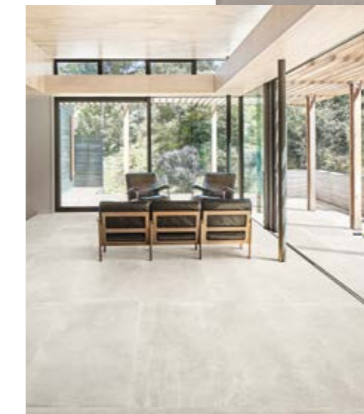

TITANIUM
CAMERA / BEDROOM
ZIMMER / CHAMBRE

37



41

NITE
BAGNO / BATHROOM
BAD / SALLE DE BAINS

ABBINAMENTI / MATCHINGS
PASSENDE KOMBINATIONEN
COLORIS COMPATIBLES

70 / 72

CARATTERISTICHE TECNICHE / TECHNICAL CHARACTERISTICS
TECHNISCHE DATEN / CARACTERISTIQUES TECHNIQUES

IN EVI DE NZA

HIGHLIGHTS

5

COLORI

COLOURS
FARBEN
COULEURS



2

SPESSORI

TICKNESS
STARKE
EPAISSEUR

⅓ 10,5 mm
⅓ 9,5 mm

4

FORMATI

SIZES
FORMATE
FORMATS

*60x120 (24"x48") NAT/RET | LEV/RET | BOCCIARDATO RET
60x60 (24"x24") NAT/RET | LEV/RET
30x60 (12"x24") NAT/RET | LEV/RET
80x80 (31¹/₂"x31¹/₂") NAT/RET | LEV/RET

*ATTENZIONE: VERIFICARE IN FASE DI ORDINE IL FORMATO E L'IMBALLO (60x120-60x119,5)
*NOTE: IN THE ORDERING PHASE PLEASE CHECK SIZE AND PACKAGING (60x120-60x119,5)
*BITTEACHTEN: BEIM BESTELLEN BITTE DAS FORMAT UND DIE VERPACKUNG KONTROLLIEREN (60x120-60x119,5)
*ATTENTION: MERCI DE VÉRIFIER EMBALLAGE ET FORMAT AU MOMENT DE LA COMMANDE (60x120-60x119,5)

LEVIGATO

3

SUPERFICI

SURFACES
OBERFLÄCHEN
SURFACES

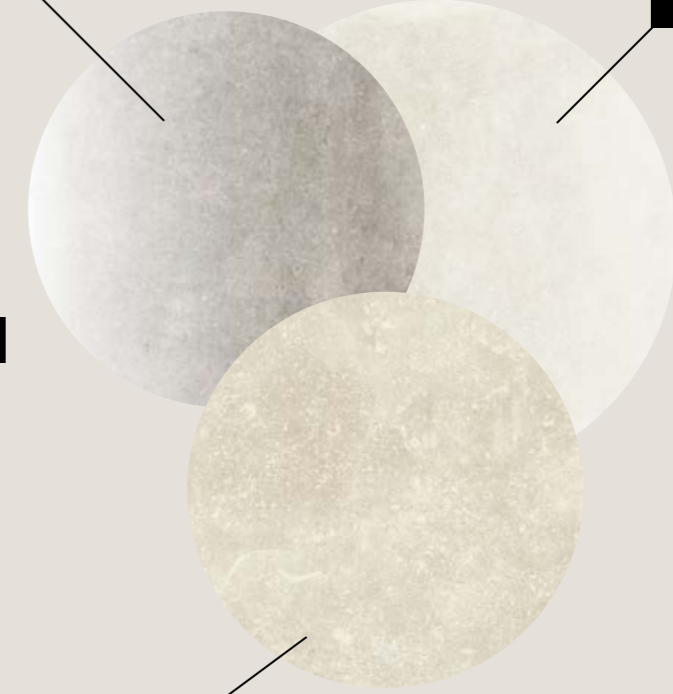

BOCCIARDATO

4

STRUTTURE 3D

3D STRUCTURES
3D-STRUKTUR
STRUCTURE 3D

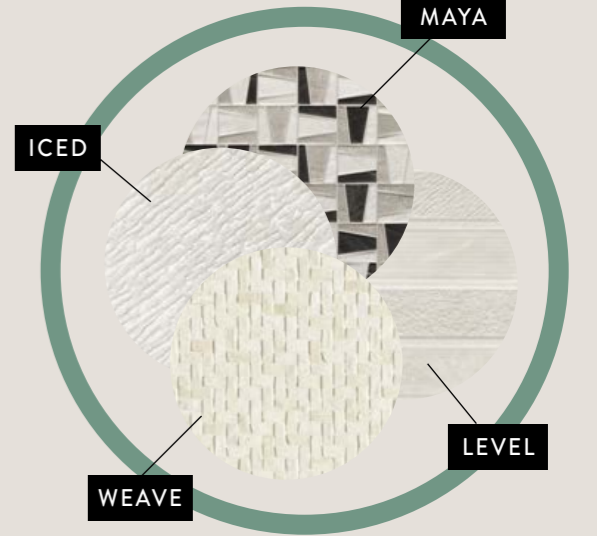

ICED

MAYA

LEVEL

WEAVE

2

DESTINAZIONI

D'USO

INTENDED USES
VERWENDUNGSZWECKE
DOMAINES D'APPLICATION

**PAVIMENTO +
RIVESTIMENTO**

FLOOR+WALL TILES
BODENFLIESE+WANDFLIESEN
SOL+REVÊTEMENT

MIX ALL IN

2

MOSAICI

MOSAICS
MOSAIKE
MOSAIQUES

MOSAICO NAT



UNIQUE-
STONE
PUBLIC
AREAS

UNIQUESTONE SILK

SHOP



UNIQUESTONE SILK MAYA RET 30x60 (12"x24")
UNIQUESTONE SILK LEV/RET 60x60 (24"x24")
UNIQUESTONE SILK NAT/RET 60x60 (24"x24")

UNIQUESTONE SILK MAYA RET 30x60 (12"x24")
UNIQUESTONE SILK LEV/RET 60x60 (24"x24")
UNIQUESTONE SILK NAT/RET 60x60 (24"x24")



UNIQUESTONE SILK MAYA RET 30x60 (12"x24")



UNIQUESTONE SILK



UNIQUESTONE SILK MAYA RET 30x60 (12"x24")
UNIQUESTONE SILK LEV/RET 60x60 (24"x24")
UNIQUESTONE SILK NAT/RET 60x60 (24"x24")

UNIQUE- STONE SILVER

AIRPORT LOUNGE



UNIQUESTONE SILVER LEVEL RET 60x120 (24"x48")
UNIQUESTONE SILVER NAT/RET 60x120 (24"x48")
UNIQUESTONE SILVER LEV/RET 60x120 (24"x48")

UNIQUE- STONE SILVER

UNIQUESTONE SILVER NAT/RET 60x120 (24"x48")
UNIQUESTONE SILVER LEV/RET 60x120 (24"x48")



UNIQUESTONE SILVER LEVEL RET 60x120 (24"x48")
UNIQUESTONE SILVER NAT/RET 60x120 (24"x48")
UNIQUESTONE SILVER LEV/RET 60x120 (24"x48")



UNIQUESTONE TITANIUM NAT/RET 60x60 (24"x24")

UNIQUESTONE *TITANIUM*

BOUTIQUE HOTEL

UNIQUE- STONE SAND

HALL



UNIQUESTONE SAND LEV/RET 80x80 (31¹/₂"x31¹/₂")

UNIQUESTONE NITE LEV/RET 80x80 (31¹/₂"x31¹/₂"")



UNIQUE- *STONE* *NITE*

RESTAURANT

UNIQUE-
STONE
RESIDENTIAL
SPACES





UNIQUE-
STONE
SAND

KITCHEN

UNIQUESTONE SAND ICED LEV/RET 30x60 (12"x24")
UNIQUESTONE SAND NAT/RET 30x60 (12"x24")

UNIQUESTONE SAND NAT/RET 30x60 (12"x24")



UNIQUESTONE STONE SAND

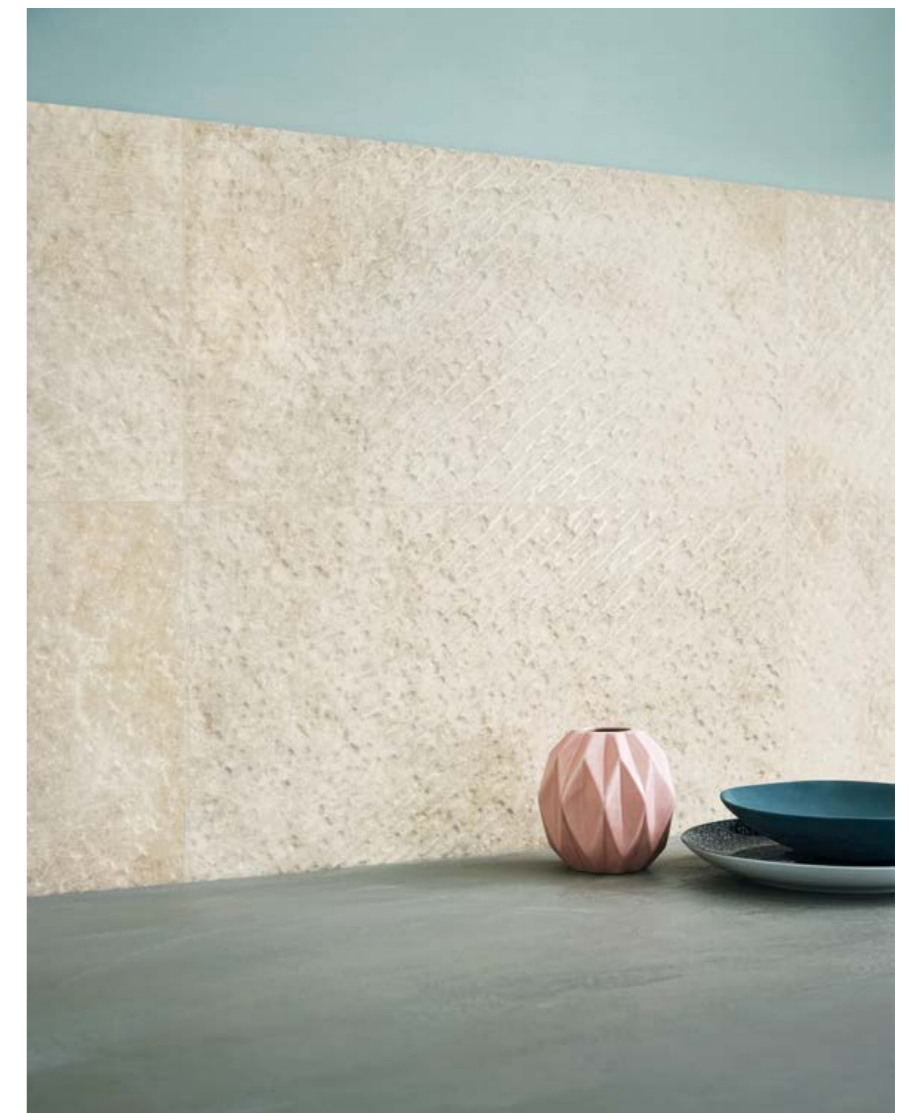

UNIQUESTONE ICED SAND LEV/RET 30x60 (12"x24")

UNIQUE- STONE SILVER

ENTRANCE

UNIQUESTONE SILVER NAT/RET 30x60 (12"x24")





UNIQUESTONE WEAVE SK/SD NAT/RET 30x60 (12"x24")
 UNIQUESTONE SILK NAT/RET 60x120 (24"x48")
 UNIQUESTONE SILK BOCCIARDATO RET 60x120 (24"x48")

UNIQUE- STONE SILK

LIVING AREA



UNIQUESTONE WEAVE SK/SD NAT/RET 30x60 (12"x24")

UNIQUESTONE

TITANIUM

BEDROOM

UNIQUESTONE TITANIUM CHEVRON NAT/RET 10x53 (4"x20")



UNIQUESTONE TITANIUM CHEVRON NAT/RET 10x53 (4"x20")

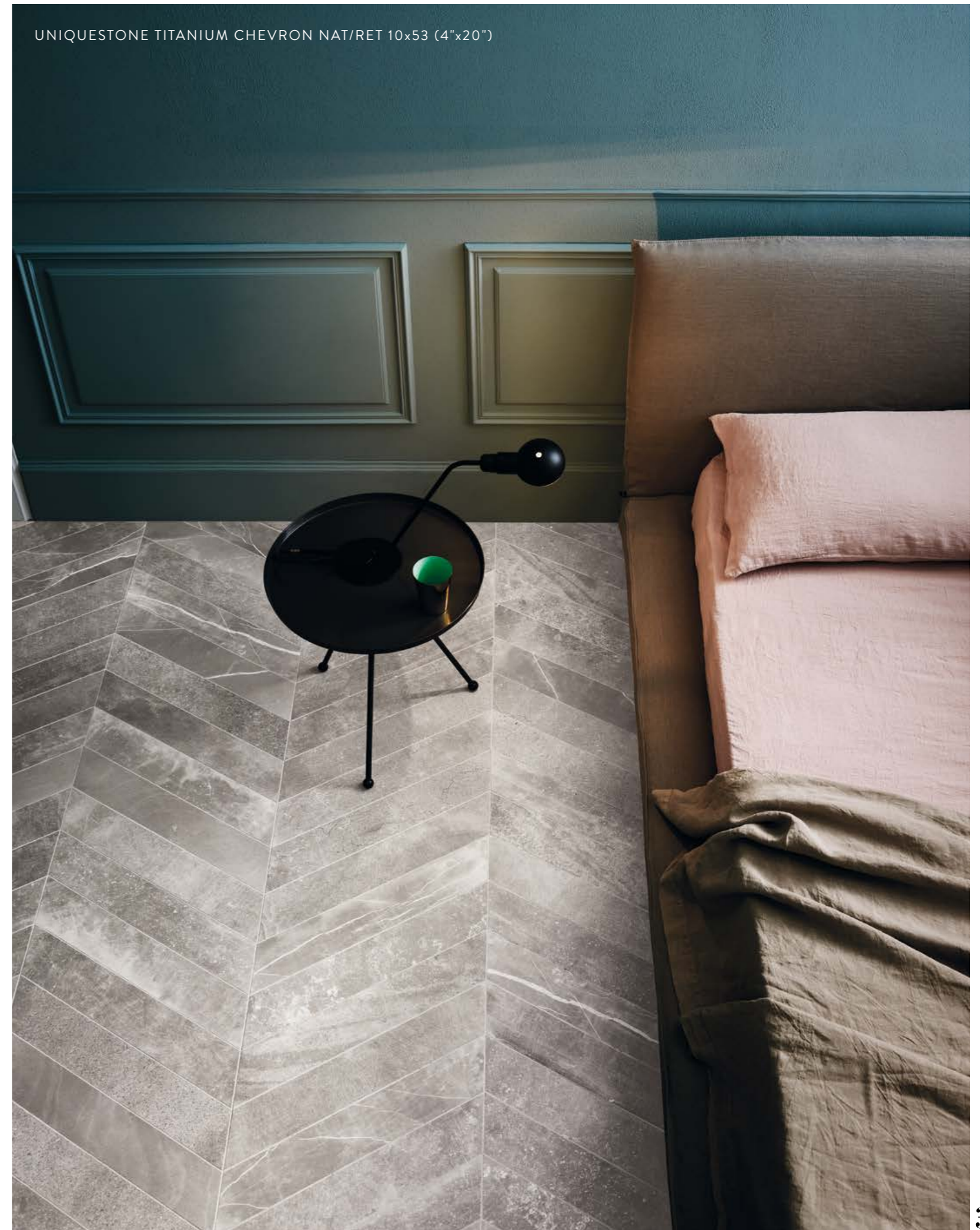



UNIQUESTONE NITE

BATHROOM

UNIQUESTONE NITE NAT/RET 60x120 (24"x48")



UNIQUESTONE NITE NAT/RET 30x60 (12"x24")
UNIQUESTONE NITE MIX ALL IN RET 30x30 (12"x12")
UNIQUESTONE NITE NAT/RET 60x120 (24"x48")



UNIQUESTONE NITE NAT/RET 30x60 (12"x24")
UNIQUESTONE NITE MIX ALL IN RET 30x30 (12"x12")
UNIQUESTONE NITE NAT/RET 60x120 (24"x48")

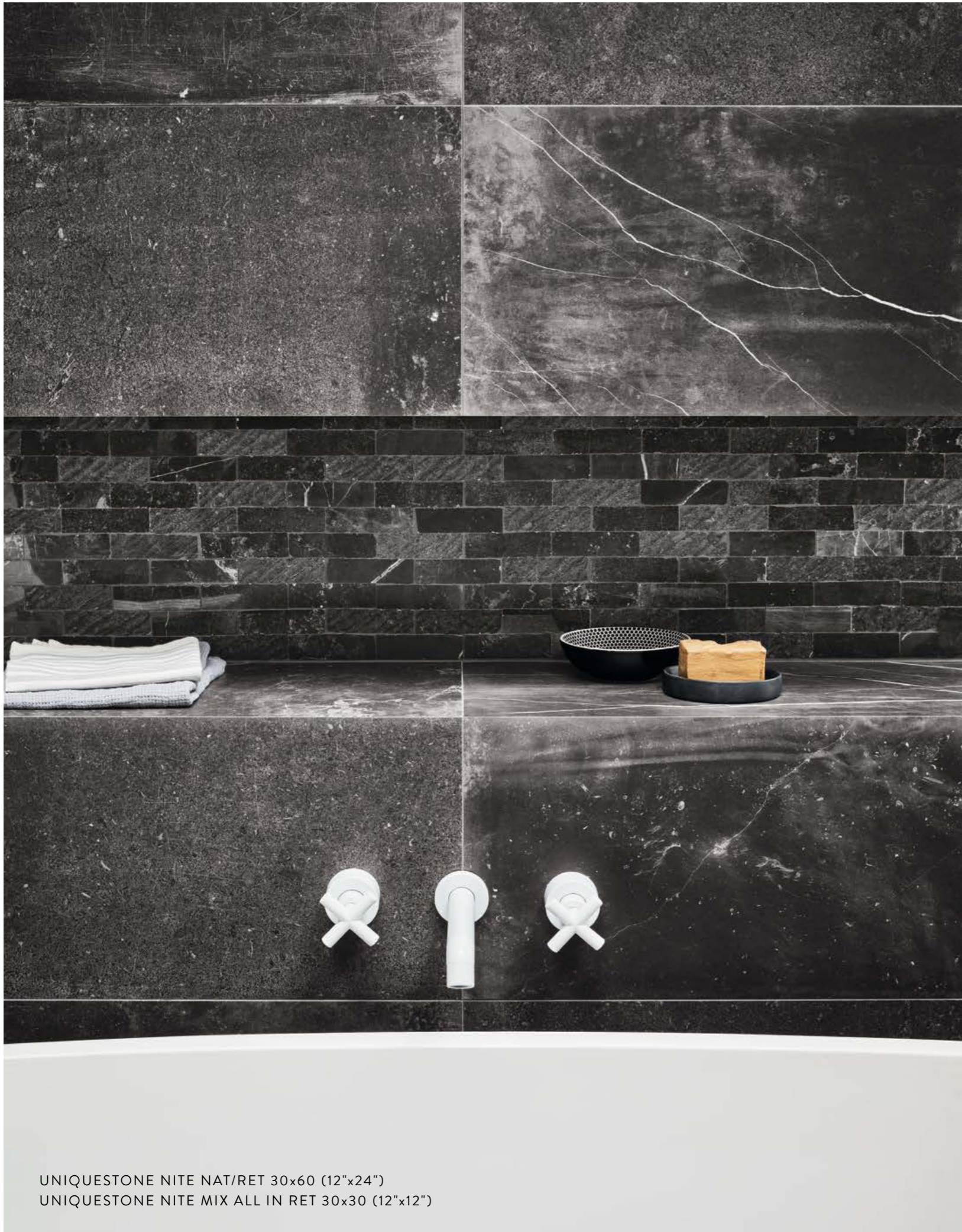

UNIQUESTONE NITE NAT/RET 30x60 (12"x24")
UNIQUESTONE NITE MIX ALL IN RET 30x30 (12"x12")

UNIQUESTONE NITE

UNIQUESTONE NITE NAT/RET 30x60 (12"x24")
UNIQUESTONE NITE MIX ALL IN RET 30x30 (12"x12")



UNIQUESTONE SILK 30x60 (12"x24")

UNIQUESTONE SILK

GRES FINE PORCELLANATO AD IMPASTO COLORATO
COLOURED-BODY FINE PORCELAIN STONEWARE
FEINSTEINZEUG AUS FARBIGER MASSE
GRÈS CÉRAME FIN À PÂTE COLORÉE

TECNOLOGIA DIGITALE
DIGITAL TECHNOLOGY
DIGITAL TECHNOLOGIE
TECHNOLOGIE NUMÉRIQUE

FORMATI

SIZES | FORMATE | FORMATS 60x120 (24"x48") | 80x80 (31¹/₂"x31¹/₂") | 60x60 (24"x24") | 30x60 (12"x24")



9,5

60x60 (24"x24")
01702 | UNIQUE SILK NAT/RET U4 P4 E3 C2
01691 | UNIQUE SILK LEV/RET



9,5

30x60 (12"x24")
01707 | UNIQUE SILK NAT/RET U4 P3 E3 C2
01696 | UNIQUE SILK LEV/RET

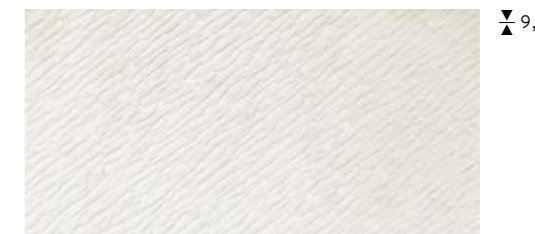

9,5

30x60 (12"x24")
01765 | UNIQUE SILK ICED LEV/RET



9,5

30x30 (12"x12")
01786 | UNIQUE SILK MIX ALL IN RET



9,5

30x60 (12"x24")
01918 | UNIQUE WEAVE SK/SD NAT/RET

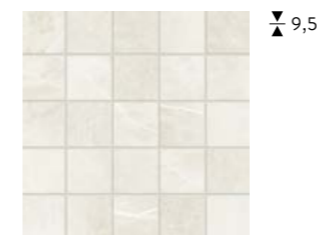

9,5

30x30 (12"x12")
01771 | UNIQUE SILK MOSAICO NAT/RET

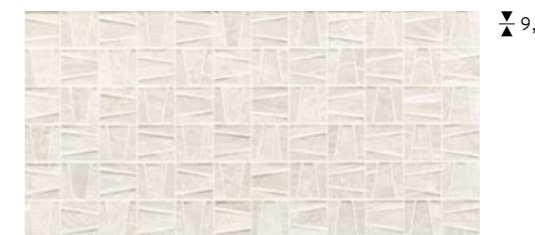

9,5

30x60 (12"x24")
01781 | UNIQUE SILK MAYA RET

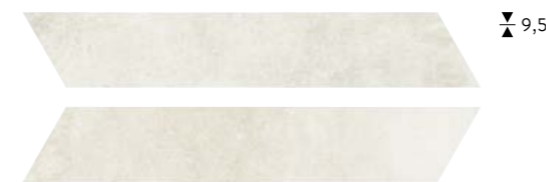

9,5

10x53 (4"x20")
01792 | UNIQUE SILK CHEVRON NAT/RET U4 P3 E3 C2



9,5

30x60 (12"x24")
01785 | UNIQUE NITE MAYA DESIGN RET

UNIQUESTONE SILK

GRES FINE PORCELLANATO AD IMPASTO COLORATO
COLOURED-BODY FINE PORCELAIN STONEWARE
FEINSTEINZEUG AUS FARBIGER MASSE
GRÈS CÉRAME FIN À PÂTE COLORÉE

TECNOLOGIA DIGITALE
DIGITAL TECHNOLOGY
DIGITAL TECHNOLOGIE
TECHNOLOGIE NUMÉRIQUE

10,5



80x80 (31 1/2" x 31 1/2")
01753 | UNIQUE SILK NAT/RET
01759 | UNIQUE SILK LEV/RET

U4 P3 E3 C2

10,5



60x120 (24" x 48")
01716 | UNIQUE SILK NAT/RET
01722 | UNIQUE SILK LEV/RET

U4 P3 E3 C2

10,5



60x120 (24" x 48")
01727 | UNIQUE SILK BOCCIARDATO RET

10,5



60x120 (24" x 48")
01733 | UNIQUE SILK LEVEL RET

UNIQUESTONE SAND 60x60 (24"x24")

UNIQUESTONE SAND

GRES FINE PORCELLANATO AD IMPASTO COLORATO
COLOURED-BODY FINE PORCELAIN STONEWARE
FEINSTEINZEUG AUS FARBIGER MASSE
GRÈS CÉRAME FIN À PÂTE COLORÉE

TECNOLOGIA DIGITALE
DIGITAL TECHNOLOGY
DIGITAL TECHNOLOGIE
TECHNOLOGIE NUMÉRIQUE

FORMATI

SIZES | FORMATE | FORMATS 60x120 (24"x48") | 80x80 (31¹/₂"x31¹/₂") | 60x60 (24"x24") | 30x60 (12"x24")



60x60 (24"x24")
01703 | UNIQUE SAND NAT/RET U4 P4 E3 C2
01692 | UNIQUE SAND LEV/RET



30x60 (12"x24")
01708 | UNIQUE SAND NAT/RET U4 P3 E3 C2
01697 | UNIQUE SAND LEV/RET

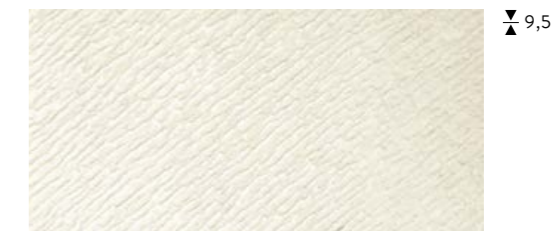

30x60 (12"x24")
01766 | UNIQUE SAND ICED LEV/RET



30x30 (12"x12")
01787 | UNIQUE SAND MIX ALL IN RET



30x60 (12"x24")
01918 | UNIQUE SAND WEAVE SK/SD NAT/RET

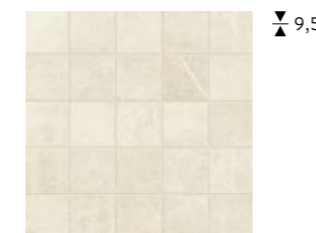

30x30 (12"x12")
01772 | UNIQUE SAND MOSAICO NAT/RET



30x60 (12"x24")
01782 | UNIQUE SAND MAYA RET

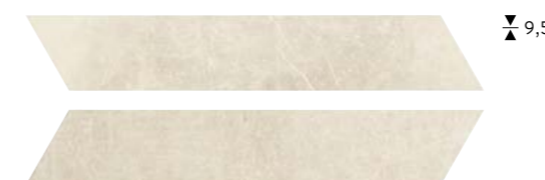

10x53 (4"x20")
01793 | UNIQUE SAND CHEVRON NAT/RET U4 P3 E3 C2

UNIQUESTONE SAND

GRES FINE PORCELLANATO AD IMPASTO COLORATO
COLOURED-BODY FINE PORCELAIN STONWARE
FEINSTEINZEUG AUS FARBIGER MASSE
GRÈS CÉRAME FIN À PÂTE COLORÉE

TECNOLOGIA DIGITALE
DIGITAL TECHNOLOGY
DIGITAL TECHNOLOGIE
TECHNOLOGIE NUMÉRIQUE

10,5



80x80 (31 1/2" x 31 1/2")
01754 | UNIQUE SAND NAT/RET
01761 | UNIQUE SAND LEV/RET

U4 P3 E3 C2

10,5



60x120 (24" x 48")
01717 | UNIQUE SAND NAT/RET
01723 | UNIQUE SAND LEV/RET

U4 P3 E3 C2

10,5



60x120 (24" x 48")
01728 | UNIQUE SAND BOCCIARDATO RET

10,5



60x120 (24" x 48")
01734 | UNIQUE SAND LEVEL RET

UNIQUESTONE SILVER 60x60 (24"x24")

UNIQUESTONE SILVER

GRES FINE PORCELLANATO AD IMPASTO COLORATO
COLOURED-BODY FINE PORCELAIN STONEWARE
FEINSTEINZEUG AUS FARBIGER MASSE
GRÈS CÉRAME FIN À PÂTE COLORÉE

TECNOLOGIA DIGITALE
DIGITAL TECHNOLOGY
DIGITAL TECHNOLOGIE
TECHNOLOGIE NUMÉRIQUE

FORMATI

SIZES | FORMATE | FORMATS 60x120 (24"x48") | 80x80 (31¹/₂"x31¹/₂") | 60x60 (24"x24") | 30x60 (12"x24")



9,5

60x60 (24"x24")
01704 | UNIQUE SILVER NAT/RET U4 P4 E3 C2
01693 | UNIQUE SILVER LEV/RET



9,5

30x60 (12"x24")
01709 | UNIQUE SILVER NAT/RET U4 P3 E3 C2
01698 | UNIQUE SILVER LEV/RET

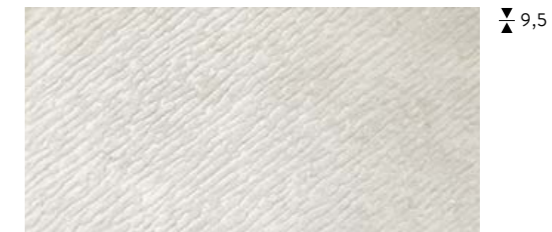

9,5

30x60 (12"x24")
01767 | UNIQUE SILVER ICED LEV/RET



9,5

30x30 (12"x12")
01788 | UNIQUE SILVER MIX ALL IN RET

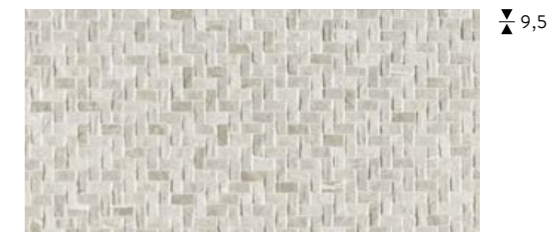

9,5

30x60 (12"x24")
01917 | UNIQUE WEAVE TM/SR NAT/RET

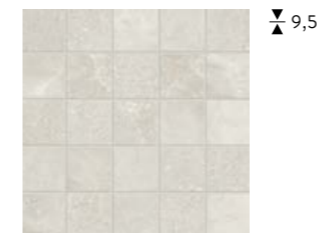

9,5

30x30 (12"x12")
01773 | UNIQUE SILVER MOSAICO NAT/RET



9,5

30x60 (12"x24")
01783 | UNIQUE SILVER MAYA RET

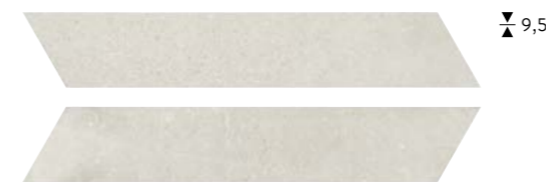

9,5

10x53 (4"x20")
01794 | UNIQUE SILVER CHEVRON NAT/RET U4 P3 E3 C2



9,5

30x60 (12"x24")
01785 | UNIQUE NITE MAYA DESIGN RET

UNIQUESTONE SILVER

GRES FINE PORCELLANATO AD IMPASTO COLORATO
COLOURED-BODY FINE PORCELAIN STONWARE
FEINSTEINZEUG AUS FARBIGER MASSE
GRÈS CÉRAME FIN À PÂTE COLORÉE

TECNOLOGIA DIGITALE
DIGITAL TECHNOLOGY
DIGITAL TECHNOLOGIE
TECHNOLOGIE NUMÉRIQUE

10,5



80x80 (31 1/2" x 31 1/2")
01755 | UNIQUE SILVER NAT/RET
01762 | UNIQUE SILVER LEV/RET

U4 P3 E3 C2

10,5



60x120 (24" x 48")
01718 | UNIQUE SILVER NAT/RET
01724 | UNIQUE SILVER LEV/RET

U4 P3 E3 C2

10,5



60x120 (24" x 48")
01729 | UNIQUE SILVER BOCCIARDATO RET

10,5



60x120 (24" x 48")
01735 | UNIQUE SILVER LEVEL RET

UNIQUESTONE TITANIUM 60x120 (24"x48")

UNIQUESTONE TITANIUM

GRES FINE PORCELLANATO AD IMPASTO COLORATO
COLOURED-BODY FINE PORCELAIN STONEWARE
FEINSTEINZEUG AUS FARBIGER MASSE
GRÈS CÉRAME FIN À PÂTE COLORÉE

TECNOLOGIA DIGITALE
DIGITAL TECHNOLOGY
DIGITAL TECHNOLOGIE
TECNOLOGIE NUMÉRIQUE

FORMATI

SIZES | FORMATE | FORMATS 60x120 (24"x48") | 80x80 (31¹/₂"x31¹/₂") | 60x60 (24"x24") | 30x60 (12"x24")



60x60 (24"x24")
01705 | UNIQUE TITANIUM NAT/RET U4P4E3C2
01694 | UNIQUE TITANIUM LEV/RET



30x60 (12"x24")
01711 | UNIQUE TITANIUM NAT/RET U4P3E3C2
01699 | UNIQUE TITANIUM LEV/RET



30x60 (12"x24")
01768 | UNIQUE TITANIUM ICED LEV/RET



30x30 (12"x12")
01789 | UNIQUE TITANIUM MIX ALL IN RET

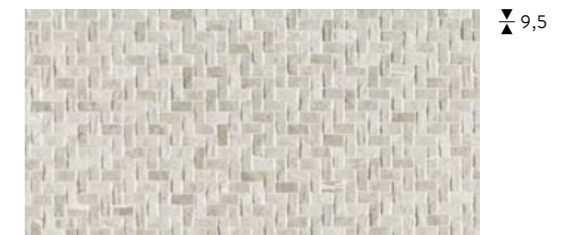

30x60 (12"x24")
01917 | UNIQUE WEAVE TM/SR NAT/RET



30x30 (12"x12")
01774 | UNIQUE TITANIUM MOSAICO NAT/RET



30x60 (12"x24")
01784 | UNIQUE TITANIUM MAYA RET



10x53 (4"x20")
01795 | UNIQUE TITANIUM CHEVRON NAT/RET U4P3E3C2



30x60 (12"x24")
01785 | UNIQUE NITE MAYA DESIGN RET

UNIQUESTONE TITANIUM

GRES FINE PORCELLANATO AD IMPASTO COLORATO
COLOURED-BODY FINE PORCELAIN STONEWARE
FEINSTEINZEUG AUS FARBIGER MASSE
GRÈS CÉRAME FIN À PÂTE COLORÉE

TECNOLOGIA DIGITALE
DIGITAL TECHNOLOGY
DIGITAL TECHNOLOGIE
TECHNOLOGIE NUMÉRIQUE

10,5



80x80 (31¹/₂"x31¹/₂")
01757 | UNIQUE TITANIUM NAT/RET
01763 | UNIQUE TITANIUM LEV/RET

U4 P3 E3 C2

10,5



60x120 (24"x48")
01719 | UNIQUE TITANIUM NAT/RET
01725 | UNIQUE TITANIUM LEV/RET

U4 P3 E3 C2

10,5



60x120 (24"x48")
01731 | UNIQUE TITANIUM BOCCIARDATO RET

10,5



60x120 (24"x48")
01739 | UNIQUE TITANIUM LEVEL RET

UNIQUESTONE NITE 80x80 (31^{1/2}"x31^{1/2}")

UNIQUESTONE

NITE

GRES FINE PORCELLANATO AD IMPASTO COLORATO
COLOURED-BODY FINE PORCELAIN STONEWARE
FEINSTEINZEUG AUS FARBIGER MASSE
GRÈS CÉRAME FIN À PÂTE COLORÉE

TECNOLOGIA DIGITALE
DIGITAL TECHNOLOGY
DIGITAL TECHNOLOGIE
TECHNOLOGIE NUMÉRIQUE

FORMATI

SIZES | FORMATE | FORMATS 60x120 (24"x48") | 80x80 (31^{1/2}"x31^{1/2}") | 60x60 (24"x24") | 30x60 (12"x24")

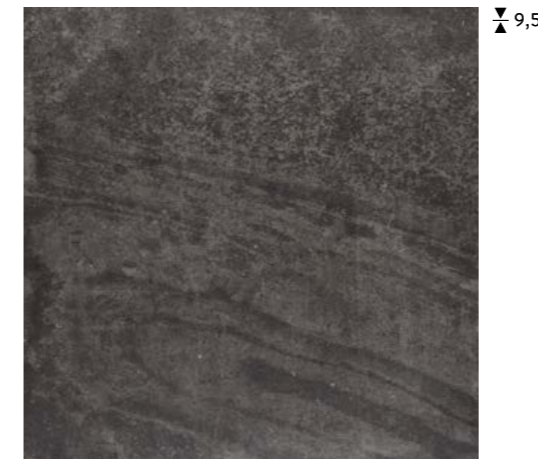

9,5

60x60 (24"x24")
01706 | UNIQUE NITE NAT/RET U4 P4 E3 C2
01695 | UNIQUE NITE LEV/RET



9,5

30x60 (12"x24")
01712 | UNIQUE NITE NAT/RET U4 P3 E3 C2
01701 | UNIQUE NITE LEV/RET

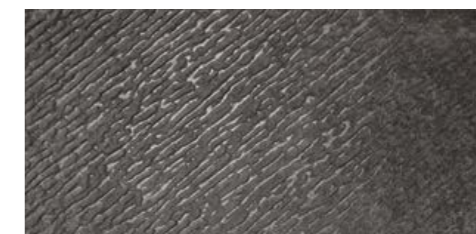

9,5

30x60 (12"x24")
01769 | UNIQUE NITE ICED LEV/RET



9,5

30x30 (12"x12")
01791 | UNIQUE NITE MIX ALL IN RET



9,5

30x30 (12"x12")
01775 | UNIQUE NITE MOSAICO NAT/RET



9,5

10x53 (4"x20")
01796 | UNIQUE NITE CHEVRON NAT/RET U4 P3 E3 C2



9,5

30x60 (12"x24")
01785 | UNIQUE NITE MAYA DESIGN RET

UNIQUESTONE NITE

GRES FINE PORCELLANATO AD IMPASTO COLORATO
COLOURED-BODY FINE PORCELAIN STONWARE
FEINSTEINZEUG AUS FARBIGER MASSE
GRÈS CÉRAME FIN À PÂTE COLORÉE

TECNOLOGIA DIGITALE
DIGITAL TECHNOLOGY
DIGITAL TECHNOLOGIE
TECHNOLOGIE NUMÉRIQUE

10,5



80x80 (31¹/₂"x31¹/₂")
01758 | UNIQUE NITE NAT/RET
01764 | UNIQUE NITE LEV/RET

U4 P3 E3 C2

10,5



60x120 (24"x48")
01721 | UNIQUE NITE NAT/RET
01726 | UNIQUE NITE LEV/RET

U4 P3 E3 C2

10,5



60x120 (24"x48")
01732 | UNIQUE NITE BOCCIARDATO RET

10,5



60x120 (24"x48")
01741 | UNIQUE NITE LEVEL RET



FASCE DI PREZZO

PRICE RANGE
PREIS GRUPPE
NIVEAU DE PRIX

	FORMATI SIZES	FORMATI										DIN 51130	DIN 51097	DCOF							
		*60x120 24"x48"	*60x119,5 24"x47 1/4"	LEVEL *60x120 24"x48"	LEVEL *60x119,5 24"x47 1/4"	80x80 - 31 1/2"x31 1/2"	60x60 - 24"x24"	30x60 - 12"x24"	MAYA 30x60 - 12"x24"	ICED 30x60 - 12"x24"	WEAVE 30x60 - 12"x24"										
		▽ 10,5	▽ 9,5	▽ 10,5	▽ 9,5	▽ 10,5	▽ 9,5	▽ 9,5	▽ 9,5	▽ 9,5	▽ 9,5										
	NAT/RET	01716	740	01733	790	01753	740	01702	550	01707	500	01781	560	01918	560	R10	A	>0.42			
	LEV/RET	01722	790			01759	770	01691	680	01696	650			01765	700				V3		
	BOCCIARDATO	01727	750																		
	NAT/RET	01717	740	01734	790	01754	740	01703	550	01708	500	01782	560	01918	560	R10	A	>0.42			
	LEV/RET	01723	790			01761	770	01692	680	01697	650			01766	700				V3		
	BOCCIARDATO	01728	750																		
	NAT/RET	01718	740	01735	790	01755	740	01704	550	01709	500	01783	560	01917	560	R10	A	>0.42			
	LEV/RET	01724	790			01762	770	01693	680	01698	650			01767	700				V3		
	BOCCIARDATO	01729	750																		
	NAT/RET	01719	740	01739	790	01757	740	01705	550	01711	500	01784	560	01917	560	R10	A	>0.42			
	LEV/RET	01725	790			01763	770	01694	680	01699	650			01768	700				V3		
	BOCCIARDATO	01731	750																		
	NAT/RET	01721	740	01741	790	01758	740	01706	550	01712	500	01785	560			R10	A	>0.42			
	LEV/RET	01726	790			01764	770	01695	680	01701	650			01769	700				V3		
	BOCCIARDATO	01732	750																		

*Attenzione: verificare in fase di ordine il formato e l'imballo (60x120-60x119,5 / 6,5x120-6,5x119,5 / 30x120-30x119,5)
 *Note: In the ordering phase please check size and packaging (60x120-60x119,5 / 6,5x120-6,5x119,5 / 30x120-30x119,5)
 *Bitteachten: Beim Bestellen bitte das Format und die Verpackung kontrollieren (60x120-60x119,5 / 6,5x120-6,5x119,5 / 30x120-30x119,5)
 *Attention: Merci de vérifier emballage et format au moment de la commande (60x120-60x119,5 / 6,5x120-6,5x119,5 / 30x120-30x119,5)

FASCE DI PREZZO

PRICE RANGE
PREIS GRUPPE
NIVEAU DE PRIX

	FORMATI SIZES	FORMATI										DIN 51130	DIN 51097	DCOF							
		MOSAICO 30x30 - 12"x12"	MOSAICO MIX ALL IN 30x30 - 12"x12"	CHEVRON 10x53 - 4"x20"	GRADINO 30x120 12"x48"	GRADINO 30x119,5 12"x47 1/4"	GRADINO 30x60 - 12"x24"	BATTISCOPA 6,5x120 2 1/2"x48"	BATTISCOPA 6,5x119,5 2 1/2"x47 1/4"	BATTISCOPA 8x80 - 3 1/8"x31 1/2"	BATTISCOPA 8x60 - 3 1/8"x24"										
		▽ 9,5	▽ 9,5	▽ 9,5	▽ 10,5	▽ 9,5	▽ 9,5	▽ 10,5	▽ 9,5	▽ 10,5	▽ 9,5										
	NAT/RET	01771	160		01792	820	01831	710	01836	200	01797	130	01808	100	01819	60	R10	A	>0.42		
	LEV/RET			01786	240					01803	170	01814	140	01825	130	V3					
	BOCCIARDATO																				
	NAT/RET	01772	160		01793	820	01832	710	01837	200	01798	130	01809	100	01821	60	R10	A	>0.42		
	LEV/RET			01787	240					01804	170	01815	140	01826	130	V3					
	BOCCIARDATO																				
	NAT/RET	01773	160		01794	820	01833	710	01838	200	01799	130	01811	100	01822	60	R10	A	>0.42		
	LEV/RET			01788	240					01805	170	01816	140	01827	130	V3					
	BOCCIARDATO																				
	NAT/RET	01774	160		01795	820	01834	710	01839	200	01801	130	01812	100	01823	60	R10	A	>0.42		
	LEV/RET			01789	240					01806	170	01817	140	01828	130	V3					
	BOCCIARDATO																				
	NAT/RET	01775	160		01796	820	01835	710	01841	200	01802	130	01813	100	01824	60	R10	A	>0.42		
	LEV/RET			01791	240					01807	170	01818	140	01829	130	V3					
	BOCCIARDATO																				

*Attenzione: verificare in fase di ordine il formato e l'imballo (60x120-60x119,5 / 6,5x120-6,5x119,5 / 30x120-30x119,5)
 *Note: In the ordering phase please check size and packaging (60x120-60x119,5 / 6,5x120-6,5x119,5 / 30x120-30x119,5)
 *Bitteachten: Beim Bestellen bitte das Format und die Verpackung kontrollieren (60x120-60x119,5 / 6,5x120-6,5x119,5 / 30x120-30x119,5)
 *Attention: Merci de vérifier emballage et format au moment de la commande (60x120-60x119,5 / 6,5x120-6,5x119,5 / 30x120-30x119,5)



IMBALLI PACKING VERPACKUNG EMBALLAGE

FORMATI SIZES		▼ ▲ MM	PEZZI SCATOLA PCS/BOX STCK/KARTON CARREAUX/BOÎTES	MQ/SCATOLA SQ/MT/BOX M2/KARTON QM/BOÎTES	KG/SCATOLA KGS/BOX KG/KARTON KG/BOÎTES	SCATOLA/PALETTA BOXES/PALLET KARTON/PALLETE BOÎTES/PALLET	MQ/PALLETTA SQ/MT/PALLET M2/PALETTE QM/PALLET	KG/PALETTA KGS/PALLET KG/PALETTE KG/PALLET	FORMATO PALETTA SIZE PALLET FORMAT PALETTE DIM. PALETTE
*60x120 (24"x48") NAT/RET	P	10,5	2	1,440	34,00	27	38,88	918	120x80x75
*60x119,5 (24"x47½") NAT/RET	P	9,5	2	1,434	31,00	30	43,02	930	120x80x75
*60x120 (24"x48") LEV/RET	P	10,5	2	1,440	34,00	27	38,88	918	120x80x75
*60x119,5 (24"x47½") LEV/RET	P	9,5	2	1,434	32,00	30	43,02	960	120x80x75
*60x120 (24"x48") BOCCIARDATO RET	P	10,5	2	1,440	34,00	27	38,88	918	120x80x75
*60x120 (24"x48") LEVEL RET	P	10,5	2	1,440	34,00	27	38,88	918	120x80x75
80x80 (31½"x31½") NAT/RET	P	10,5	2	1,280	31,50	40	51,20	1260	120x80x97
80x80 (31½"x31½") LEV/RET	P	10,5	2	1,280	31,50	40	51,20	1260	120x80x97
60x60 (24"x24") NAT/RET	P	9,5	3	1,080	21,50	40	43,20	860	120x80x75
60x60 (24"x24") LEV/RET	P	9,5	3	1,080	22,50	40	43,20	900	120x80x75
30x60 (12"x24") NAT/RET	P	9,5	6	1,080	21,50	48	51,84	1032	120x80x75
30x60 (12"x24") LEV/RET	P	9,5	6	1,080	22,50	48	51,84	1080	120x80x75
30x60 (12"x24") MAYA RET	P	9,5	6	1,080	21,50	40	43,20	860	120x80x75
30x60 (12"x24") ICED LEV/RET	P	9,5	6	1,080	21,50	40	43,20	860	120x80x75
30x60 (12"x24") WEAVE NAT/RET	P	9,5	6	1,080	21,50	40	43,20	860	120x80x75
10x53 (4"x20") CHEVRON NAT/RET	P	9,5	12	0,640	13,20	60	38,00	792	120x80x75
30x30 (12"x12") MOSAICO NAT/RET	P	9,5	5	0,450	8,50	60	-	-	-
30x30 (12"x12") MOSAICO ALL IN RET	P	9,5	6	0,540	10,20	60	-	-	-

*Attenzione: verificare in fase di ordine il formato e l'imballo (60x120-60x119,5 / 6,5x120-6,5x119,5 / 30x120-30x119,5)

*Note: In the ordering phase please check size and packaging (60x120-60x119,5 / 6,5x120-6,5x119,5 / 30x120-30x119,5)

*Bitteachten: Beim Bestellen bitte das Format und die Verpackung kontrollieren (60x120-60x119,5 / 6,5x120-6,5x119,5 / 30x120-30x119,5)

*Attention: Merci de vérifier emballage et format au moment de la commande (60x120-60x119,5 / 6,5x120-6,5x119,5 / 30x120-30x119,5)

IMBALLI PACKING VERPACKUNG EMBALLAGE

FORMATI SIZES		▼ ▲ MM	PEZZI SCATOLA PCS/BOX STCK/KARTON CARREAUX/BOÎTES	MQ/SCATOLA SQ/MT/BOX M2/KARTON QM/BOÎTES	KG/SCATOLA KGS/BOX KG/KARTON KG/BOÎTES	SCATOLA/PALETTA BOXES/PALLET KARTON/PALLETE BOÎTES/PALLET	MQ/PALLETTA SQ/MT/PALLET M2/PALETTE QM/PALLET	KG/PALETTA KGS/PALLET KG/PALETTE KG/PALLET	FORMATO PALETTA SIZE PALLET FORMAT PALETTE DIM. PALETTE
PEZZI SPECIALI / SPECIAL PIECES									
30x60 (12"x24") GRADINO NAT/RET	P	9,5	6	1,080	21,50	36	-	-	-
*30x120 (12"x48") GRADINO NAT/RET	P	10,5	3	1,080	25,00	20	-	-	-
*30x119,5 (12"x47½") GRADINO NAT/RET	P	9,5	3	1,080	20,50	20	-	-	-
8x60 (3½"x24") BATTISCOPA NAT/RET	P	9,5	10	0,480 m.l. 6,00	11,00	72	-	-	-
8x60 (3½"x24") BATTISCOPA LEV/RET	P	9,5	10	0,480 m.l. 6,00	11,00	72	-	-	-
8x80 (3½"x31½") BATTISCOPA NAT/RET	P	10,5	7	0,450 m.l. 5,60	11,00	65	-	-	-
8x80 (3½"x31½") BATTISCOPA LEV/RET	P	10,5	7	0,450 m.l. 5,60	11,00	65	-	-	-
*6,5x120 (2½"x48") BATTISCOPA NAT/RET	P	10,5	8	0,620 m.l. 9,60	14,00	48	-	-	-
*6,5x120 (2½"x48") BATTISCOPA LEV/RET	P	10,5	8	0,620 m.l. 9,60	14,00	48	-	-	-
*6,5x119,5 (2½"x47½") BATTISCOPA NAT - LEV/RET	P	9,5	8	0,621 m.l. 9,56	12,50	48	-	-	-

*Attenzione: verificare in fase di ordine il formato e l'imballo (60x120-60x119,5 / 6,5x120-6,5x119,5 / 30x120-30x119,5)

*Note: In the ordering phase please check size and packaging (60x120-60x119,5 / 6,5x120-6,5x119,5 / 30x120-30x119,5)

*Bitteachten: Beim Bestellen bitte das Format und die Verpackung kontrollieren (60x120-60x119,5 / 6,5x120-6,5x119,5 / 30x120-30x119,5)

*Attention: Merci de vérifier emballage et format au moment de la commande (60x120-60x119,5 / 6,5x120-6,5x119,5 / 30x120-30x119,5)

AB BINA MEN TI

MATCHINGS

PASSENDE KOMBINATIONEN COLORIS COMPATIBLES

UN PUNTO DI VISTA CONTEMPORANEO SU COLORI-MATERIA E AB-
BINABILITÀ CONSIGLIATI DAI NOSTRI ARCHITETTI E DESIGNER. UN
SUGGERIMENTO PER ISPIRAZIONI, RICERCA E MIX&MATCH, DALLA
MATERIA ALL'INTERIOR DESIGN, PASSANDO PER LE TENDENZE
DELLA MODA E DELL'ARREDAMENTO.

A CONTEMPORARY TAKE ON COLOURS, MATERIALS AND COMBI-
NATIONS RECOMMENDED BY OUR ARCHITECTS AND DESIGNERS.
A SUGGESTION FOR IDEAS, RESEARCH AND MIXING & MATCHING -
FROM THE MATERIAL TO THE INTERIOR DESIGN, PASSING THROU-
GH THE LATEST FASHION AND HOME DECOR TRENDS ON THE WAY.

EINE ZEITGEMÄSSE SICHT DER FARBEN, MATERIALIEN UND
KOMBINATIONEN, DIE UNSERE ARCHITEKTEN UND DESI-
GNER EMPFEHLEN. IDEEN ALS INSPIRATIONEN, STUDIEN
UND MIX&MATCH, VON DER MATERIE ÜBER MODE- UND EIN-
RICHTUNGSTRENDS ZUM INTERIEUR DESIGN.

UN POINT DE VUE CONTEMPORAIN SUR LES COULEURS/MATIÈRES
ET SUR LES ASSORTIMENTS RECOMMANDÉS PAR NOS
ARCHITECTES ET DESIGNERS. UN CONSEIL POUR LES INSPIRA-
TIONS, LA RECHERCHE ET LE MIX AND MATCH, DE LA MATIÈRE À
LA DÉCORATION D'INTÉRIEUR, EN PASSANT PAR LES TENDANCES
DE LA MODE ET DE L'AMEUBLEMENT.

ABBINAMENTI TRA SERIE

SERIES
COMBINATIONS
KOMBINATIONEN
AUS SERIEN
ASSORTIMENTS
SÉRIES

ABBINAMENTI CROMATICI

COLOUR
COMBINATIONS
FARBKOMBINATIONEN
ASSORTIMENTS
COULEURS



FRAGMENTS
RESIN CHARCOAL



BITS & PIECES
ASH GRAIN



PURESTONE
ANTRACITE



PURESTONE
PIOMBO



NEW STONE
LONDON GREY



COTTAGE
CARPINO



GEOSTONE
TERRA



WOOD SELECTION
DÉCAPÉ
WHITE



FRAGMENTS
RESIN TAN



WOOD SELECTION
DÉCAPÉ
ASH



SILK

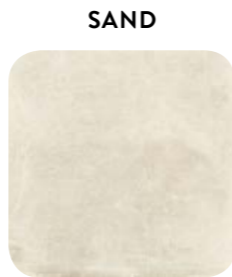

SAND

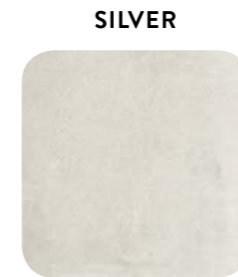

SILVER



TITANIUM

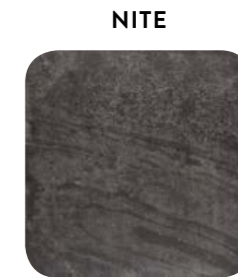

NITE



PANTONE
442 U



PANTONE
194 U



PANTONE
476 U



PANTONE
428 U



PANTONE
7536 U



PANTONE
445 U



PANTONE
196 U



PANTONE
626 U



PANTONE
492 U



PANTONE
7544 U



PANTONE
5483 U



PANTONE
446 U



PANTONE
601 U



PANTONE
623 U



PANTONE
5473 U

ABBINAMENTI TRA SERIE

SERIES
COMBINATIONS
KOMBINATIONEN
AUS SERIEN
ASSORTIMENTS
SÉRIES

ABBINAMENTI CROMATICI

COLOUR
COMBINATIONS
FARBKOMBINATIONEN
ASSORTIMENTS
COULEURS

GUIDA ALLA LETTURA

READING GUIDE / LESEANLEITUNG / GUIDE A LA LECTURE



RIVESTIMENTO
WALL TILES
WANDFLIESEN
REVÊTEMENT



PAVIMENTO
FLOOR TILES
BODENFLIESE
SOL



SPESSORE
THICKNESS
STÄRKE
ÉPAISSEUR



GRES FINE PORCELLANATO
PORCELAIN STONeware
FEINSTEINZEUG
GRÈS CÉRAMe



FASCIA PREZZO AL METRO QUADRATO
SQUARE METER PRICE RANGE
QUADRATMETER PREISGRUPPE
NIVEAU DE PRIX AU MÈTRE CARRÉ



FASCIA PREZZO AL PEZZO
PRICE RANGE PER PIECE
STÜCK PREISGRUPPE
NIVEAU DE PRIX À LA PIÈCE

>

VARIAZIONE NELLE SFUMATURE DI COLORE
COLOR SHADE VARIATIONS
VARIATION DER FARBUANCEN
VARIATION DES NUANCES DE COULEUR

V1

ASPETTO UNIFORME
UNIFORM APPEARANCE
GLEICHFÖRMIGES AUSSEHEN
ASPECT UNIFORME

V2

VARIAZIONE LEGGERA
SLIGHT VARIATION
LEICHTE VARIATION
LÉGÈRE VARIATION

V3

VARIAZIONE MODERATA
MODERATE VARIATION
MÄSSIGE VARIATION
VARIATION MODESTE

V4

VARIAZIONE CASUALE
RANDOM VARIATION
ZUFÄLLIGE VARIATION
VARIATION FORTUITE

TUTTI I FORMATI SONO NOMINALI.
ALL SIZES ARE NOMINAL.
DIE FORMATE SIND NENNWERTE.
TOUS LE FORMATS SONT NOMINAUX.

GLI SPESSORI RIPORTATI IN QUESTO CATALOGO SONO NOMINALI E POSSONO VARIARE A SECONDA DEI FORMATI E DELLE FINITURE.
THE THICKNESS MENTIONED ON THIS CATALOGUE ARE NOMINAL AND CAN BE DIFFERENT ACCORDING TO THE SIZES AND THE FINISHES.
DIE IN DIESEM KATALOG ANGEGBENEN FLIESENSTÄRKE SIND NOMINAL UND KÖNNEN, JE NACH FORMAT ODER OBERFLÄCHE, VERSCHIEDEN SEIN.
LES ÉPAISSEURS REPORTÉES SUR CE CATALOGUE SONT NOMINALES ET PEUVENT VARIER SUIVANT LES FORMATS ET LES FINITIONS.

I COLORI E LE CARATTERISTICHE ESTETICHE DEI PRODOTTI SONO QUANTO PIÙ POSSIBILE VICINI A QUELLI REALI, NEI LIMITI CONSENTITI DAI PROCESSI DI STAMPA.
THE COLOURS AND APPEARANCE FEATURES OF THE PRODUCTS ARE AS CLOSE AS POSSIBLE TO REALITY, WITHIN THE LIMITATION OF THE PRINTING PROCESS.
DIE FARBEN UND DIE ÄSTHETISCHEN EIGENSCHAFTEN DER PRODUKTE ENTSPRECHEN DER WIRKLICHKEIT, INNERHALB DEN VON DEM DRUCKVERFAHREN ERLAUBTEN GRENZEN.
LES COULEURS ET LES CARACTÉRISTIQUES ESTHÉTIQUES SONT FIDÈLES AUX COULEURS ET CARACTÉRISTIQUE RÉELLES DANS LES LIMITES DES PROCÉDÉS D'IMPRESSION.

INDUSTRIE CERAMICHE PIEMME S.P.A.

VIA DEL CROCIALE 42/44
41042 FIORANO (MO) - ITALY
TEL. +39 0536.849111
FAX +39 0536.849402
WWW.CERAMICHEPIEMME.IT
INFO@CERAMICHEPIEMME.IT

STAMPA
GRAFICHE PIOPPI, ITALIA
FEBBRAIO 2019



SUN68



ALPES INOX
SMEG
SAMBONET
DORNBRACHT



LAPALMA



RESTART MILANO
COGAL
SOCIETY



RUBINETTERIA GUGLIELMI
SOCIETY
FONTANAARTE

CERAMICHE **PIEMME**
FLOOR AND MORE

INDUSTRIE CERAMICHE PIEMME S.P.A.

VIA DEL CROCIALE 42/44 - 41042 FIORANO (MO) - ITALY
TEL. +39 0536.849111 - FAX +39 0536.849402
WWW.CERAMICHEPIEMME.IT - INFO@CERAMICHEPIEMME.IT